

3D TENDER[®]

HIGH PERFORMANCE RESEARCH & DEVELOPMENT



HIGH PERFORMANCE RESEARCH & DEVELOPMENT

HIGH QUALITY 3D TENDER



Semi-rigid polyester hull, aluminum hull, removable floors, ultra-lightweight dinghies with high pressure inflatable hull... The 3D TENDER range offers unrivaled choice of models to value / price on the market

ENVIRONMENT

We pay a great attention to the respect of the environment during the production of 3D Tender boats. We make sure to use non-polluting process, energy economic respecting the health of employees and users. The choice of raw materials is also crucial since it allows to build very strong but also close to nature boats.

FEATHERWEIGHT 3D TENDER

The aluminum hull boats bring their strength while giving them an unbeatable advantage in terms of weight. These boats can be powered by small engines, cheaper, more fuel efficient, reducing their CO₂ emissions.

ALUMINIUM 3D TENDER

Aluminum is one of the only materials that can be recycled so without losing its unlimited qualities and properties .

3D Tender chose to use powder paint. These powders are electrically charged and are sprayed onto the prepared surfaces before placing in the oven. The finish is impeccable, the painted surfaces are smooth and shiny.

The powder paints bring considerable advantages compared to paintings conventional liquid:

- No volatile organic mixture
 - No solvent (no disk of the sun , pollution, etc...)
 - No pollution, excess powder is easily collected by suction
- Time and curing temperature were significantly improved in order to reduce energy consumption of the process.

TESTS CONDUCTED ON PAINTING

- Adhesion of primer (BS EN 12206-1)
- Thickness of coatings (ISO 2178)
- Grip paint / support (ISO 2409 and ISO 4624)
- Accelerated UV (ISO 11507)
- Accelerated salt spray (ISO 9227)
- Resistance to impact (ISO 6272)

TESTS CONDUCTED ON TISSUES AND ASSEMBLIES

- Mechanical properties (ISO 1421, ISO 4674 and ISO 2411)
- Assemblies Resistance to heat (ISO 6185)
- Sealed floats (ISO 6185)
- Accelerated UV (ISO 4892)

PATROL

LIMITED EDITION



3D TENDER[®]
HIGH PERFORMANCE RESEARCH & DEVELOPMENT

Patrol **Limited edition**

With the success of the PATROL range, which is highly regarded for its performance in all conditions, 3D TENDER decided this year to develop this range by designing four different models all available in five sizes, from 530 to 650 cm, in order to satisfy everybody's needs.

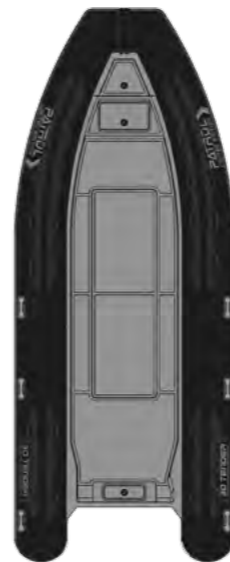

BLACK
PVC Melher Black

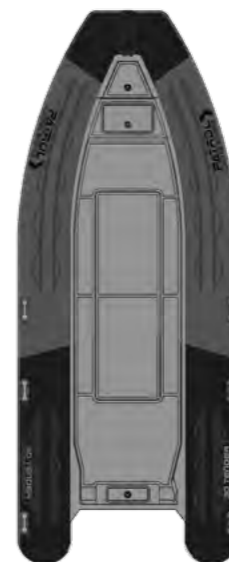

HYPALON
Hypalon Orca

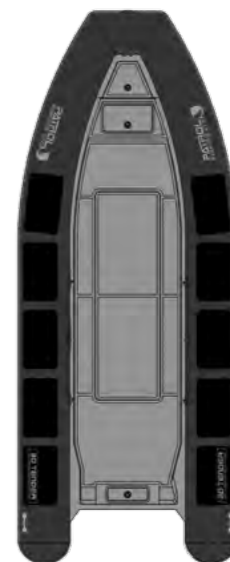

FISHING
PVC Melher Grey

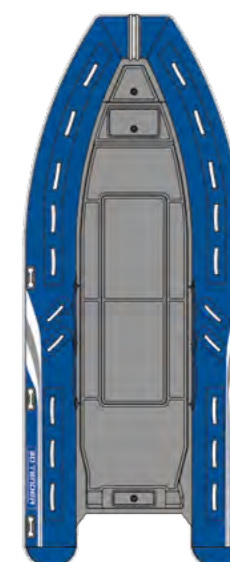

FAMILY
PVC Melher Blue

Four models available in five sizes:
530 - 550 - 560 - 600 - 650 (cm)



Patrol Limited edition

The **Patrol Limited edition** are considered as the elite of semi-rigid in our range. It comes in 5 sizes all made of **PVC Mehler Valmex® Technology** (German fabric) thermo-welded or glued hot also available in **Hypalon Orca Pennel & Flipo**.

Thanks to the study of specific environmental constraints and research performance, the **Patrol Limited edition** was developed for professionals who want a boat to all events, tailored precisely to their requirements and needs.

Outsized reliability, with unmatched performance and capacity without limit.

Range suitable for Special Forces, rescue organizations, but also offshore industries, integration on yachts or expeditions and adventures).

STANDARD EQUIPMENT

- Fabric PVC Melher technology Valmex® glued
- Anchor well
- Front box
- Lifting points & towing eyes
- Anti-slip deck
- Double Heavy duty rubbing strake
- Length keel guard
- Pump, paddles & repair kit
- Console & driver seat
- Double lifelines
- Carry handles
- Reinforcement of cones
- Retractable Cleat
- Pump, Repair kit

CONSOLE ET SEAT

PATROL 650:

Console XL
+ Bolster seat XL



PATROL 600 & 550:

Console L
+ Bolster seat L



PATROL 530:

Console
+ Lining post



See details of console and accessories [page 34 - 35](#)

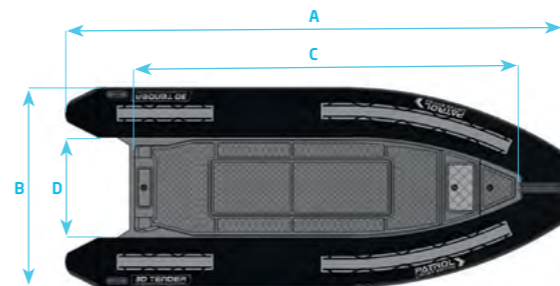

Specifications

Model	PATROL 650	PATROL 600	PATROL 560	PATROL 550	PATROL 530	
A Overall length (cm)	650	600	560	550	530	
B Overall beam (cm)	250	240	220	240	220	
C Inside length (cm)	530	475	430	430	403	
D Inside beam (cm)	150	142	120	123	120	
Total weight (Kg)	450	350	280	290	230	
Max. passengers	15	13	10	11	9	
Tube (cm)	57	57	49	57	49	
Number of airtight chambers	6	5	5	6	5	
Shaft	Long	Long	Long	Long	Long	
Max. power	150 HP	135 HP	100 HP	115 HP	90 HP	
Front locker	Standard	Standard	Standard	Standard	Standard	
Fuel tank storage	Option 86 L	Option 86 L	Option 86 L	Option 86 L	Option 86 L	
Console & Seat pilot	Standard	Standard	Standard	Standard	Standard	
PVC Melher tech. valmex	Price	10 990 €	9 990 €	7 790 €	7 990 €	7 490 €
Hypalon Orca Pennel & Flipo	Price	13 990 €	12 990 €	9 790 €	9 990 €	9 490 €

All prices are presented inclusive of VAT

Make and model filed with WIPO and INPI (hull and deck plan, console and forceps, stainless steel seat). Prices and technical data subject to change without notice.

XPRO



3D TENDER[®]
HIGH PERFORMANCE RESEARCH & DEVELOPMENT



XPRO

The **XPRO** range includes 6 models all made of **PVC Mehler Valmex® Technology** (German fabric) thermo-welded or glued hot also available in **Hypalon Orca Pennel & Flipo**.

Range completely modular, upgrade your boat according to your wishes and needs (driver seat, console and accessories are placed where you want). Fast boats, stable and easy to handle.

The range is ideal for fishing and family, the best quality / price ratio!

STANDARD EQUIPMENT

- Fabric PVC Melher technology Valmex® glued or welded seams
- Anchor well
- Front box
- Lifting points & towing eyes
- Anti-slip deck
- Double Heavy duty rubbing strake
- Length keel guard
- Pump, paddles & repair kit
- Cover entire wintering
- Console & driver seat
- Double lifelines
- Carry handles
- Reinforcement of cones
- Pump, Repair kit

CONSOLE & SEAT INCLUDED

XPRO 589:

Console + Bolster seat



XPRO 535, 490 & 445:

Console + Seat



OPTION XPRO in replacement of the standard equipment

XPRO 589:

Console L + Bolster seat L
+ 1 190 €^{VAT inc.}



XPRO 535, 490 & 445:

Console + Bolster seat
+ 590 €^{VAT inc.}

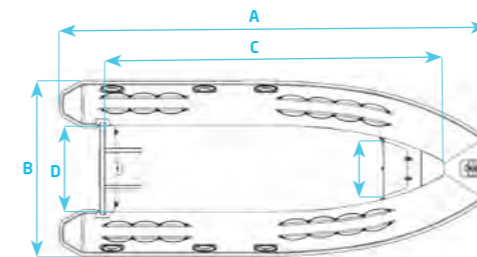

Specifications

Model	FIBERGLASS CONSTRUCTION				RIB ALUMINIUM REINFORCED	
	XPRO 589	XPRO 535	XPRO 490	XPRO 445	XPRO 420	XPRO 390
A Overall length (cm)	589	535	490	445	420	390
B Overall beam (cm)	252	212	208	208	187	186
C Inside length (cm)	472	368	335	303	293	272
D Inside beam (cm)	133	101	101	101	89	86
E Bow locker width (cm)	-	-	-	-	-	-
F Stern height (cm)	83	73	72	72	67	58
G Bow height (cm)	127	119	114	112	103	103
Total weight (Kg)	400	234	178	167	128	113
Max. passengers	16	10	7	7	8	7
Max load (Kg)	1800	1350	880	800	900	700
Tube (cm)	57	52	52	52	50	45
Number of airtight chambers	6	6	6	6	4	3
Shaft	Long	Long	Long	Long	Long	Long
Max. power	120 HP	75 HP	60 HP	50 HP	60 HP	50 HP
Front locker	Standard	Standard	Standard	Standard	Standard	Standard
Fuel tank storage	Option 58 L	Option 58 L	Option 58 L	Option 58 L	Option 25 L	Option 25 L
Console & seat	Standard	Standard	Standard	Standard	Option	Option
PVC Melher tech. valmex	Price 8 790 €	5 990 €	5 390 €	4 990 €	4 490 €	3 990 €
Hypalon Orca Pennel & Flipo	Price 10 690 €	7 490 €	6 390 €	5 990 €	6 490 €	5 990 €

All prices are presented inclusive of VAT

See details on console & accessories

page 34 - 35

Make and model filed with WIPO and INPI (hull and deck plan, console and forceps, stainless steel seat). Prices and technical data subject to change without notice.

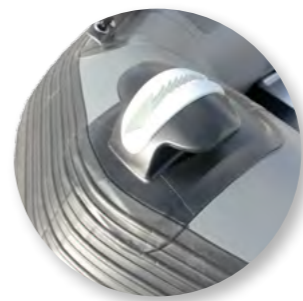

PATROL Limited Edition

Foldable

This range of foldable boats is composed by three models all build with **PVC Mehler Technologie Valmex®** (german tissu) thermo-welded or glued hot. The foldable **PATROL Limited Edition** are designed with a dismantable aluminium floor and a V shaped inflatable hull.

This range, especially created for professionals, is defintly build to last with many reinforcements disposed in all critical areas.

- ÉQUIPEMENT STANDARD**
- Fabric PVC Mehler technology Valmex® glued
 - Anchor well
 - Double rubbing strake
 - Life ropes
 - Carry handles
 - Adjustable benches
 - 2 oars
 - 2 carrying bag
 - Pump
 - Repair kit

OPTION

LAUNCHING WHEELS
269 € VAT inc.



See details on console & accessories page 34 - 35

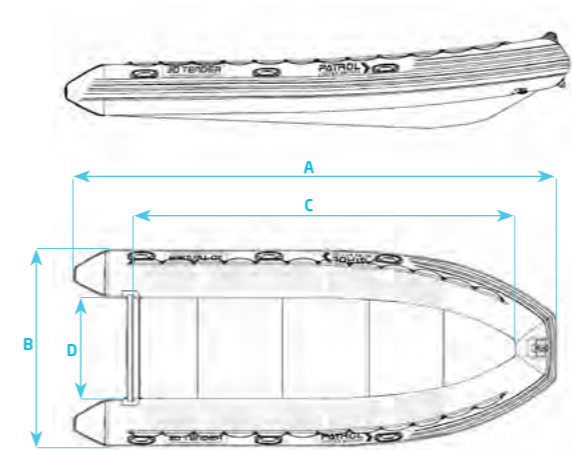

Specifications

Model	M 475	M 425	M 380	
A Overall length (cm)	475	425	380	
B Overall beam (cm)	190	183	175	
C Inside length (cm)	338	308	263	
D Inside beam (cm)	92	92	80	
Total weight (Kg)	120	110	90	
Max. passengers	9	8	6	
Max. load (Kg)	1 100	880	800	
Tube (cm)	50	46	45	
Number of airtight chambers	3+1	3+1	3+1	
Shaft	Court	Court	Court	
Max. power (Ch/Kw)	50 HP	50 HP	35 HP	
Dimensions in bag (cm)	133x69x39	131x66x39	121x66x38	
PVC Mehler tech. valmex	Price	2 490€	2 290 €	1 990 €

All prices are presented inclusive of VAT

Make and model filed with WIPO and INPI (hull and deck plan, console and forceps, stainless steel seat). Prices and technical data subject to change without notice.



XPRO Heavy Duty

The **XPRO Heavy Duty** range is available in seven models all made in **1600 decitex PVC** thermo-welded or glued hot and offers a V-shaped hull inflatable floor with a removable aluminum.

This range offers an excellent compromise between comfort and safety, a quick start and a surprising interior space.

Comfortable and versatile boat for excursions, fishing trips or diving fabulous.

Partner at all times!

STANDARD EQUIPMENT

- Fabric PVC 1600 Decitex glued or welded seams
- Anchor well
- Cover entire wintering
- 2 adjustable benches
- 2 oars
- 2 carrying bags
- 2 storage bags under the bench
- Pump
- Repair kit

OPTIONS XPRO HEAVY DUTY

Dinghy wheels
99 € VAT inc.



Launching wheels
269 € VAT inc.

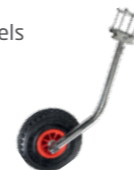

See details on console & accessories

page 34 - 35

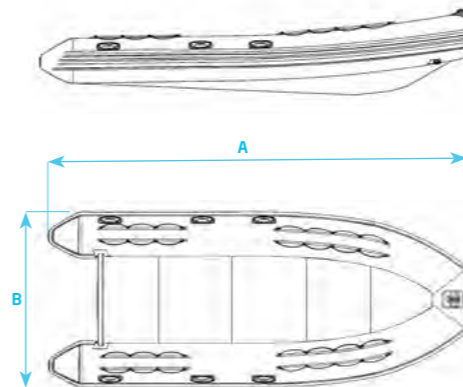

Specifications

Model	HD 550	HD 500	HD 460	HD 420	HD 380	HD 360	HD 320
A Overall length (cm)	550	500	460	420	380	360	320
B Overall beam (cm)	208	193	190	190	170	168	141
Total weight (Kg)	130	118	98	88	78	68	56
Max. passengers	10	9	8	7	6	5	5
Max load (Kg)	1300	1200	1100	1087	727	689	566
Tube (cm)	55	55	50	50	45	45	42
Number of airtight chambers	4+1	4+1	4+1	3+1	3+1	3+1	3+1
Shaft	Long	Long	Short	Short	Short	Short	Short
Max. power	45 HP	45 HP	40 HP	30 HP	20 HP	20 HP	25 HP
Dimensions en bag (cm)	149x79x49	133x69x39	133x69x39	131x66x39	121x66x38	107x66x38	107x66x38
PVC Price	2 990 €	2 720 €	2 290 €	1 990 €	1 790 €	1 690 €	1 490 €

All prices are presented inclusive of VAT

Make and model filed with WIPO and INPI (hull and deck plan, console and forceps, stainless steel seat). Prices and technical data subject to change without notice.

XPRO

RIB Aluminium



3D TENDER[®]
HIGH PERFORMANCE RESEARCH & DEVELOPMENT



XPRO RIB Aluminium

The XPRO RIB range includes 7 models all made of PVC Mehler Valmex® Technology (German fabric) thermo-welded or glued hot also available in Hypalon Orca Pennel & Flipo.

Combining a sporty and elegant design XPRO RIB is ideal for those who need a comfortable, lightweight boat. Each model is equipped with a rugged aluminum hull with a double floor and a front locker for storing the nurse (360, 390, 415).

These boats can achieve a good cruising speed with small engines and offer an important and significant fuel economy

STANDARD EQUIPMENT

- Fabric PVC Melher technology Valmex® glued or welded seams
- Inflation valves
- Aluminum hull, anti corrosion treated
- Marine paint on aluminum powder
- Anchor well
- Front locker from 360 cm
- U-bolts of lifting and towing integrated to the hull
- Slip coating UV resistant marine
- Ultra wide band chafing
- Protection bow
- Double References
- Aluminum bench slide
- Pump, oars, repair kit



Front locker
On all hypalon models and on all models from 415 to 360 cm

Option 1
Jockey console
879 € VAT inc.



Dinghy wheels
99 € VAT inc.



Launching wheels
269 € VAT inc.



See details on console & accessories page 34 - 35

Available colors:
White, Grey & Black

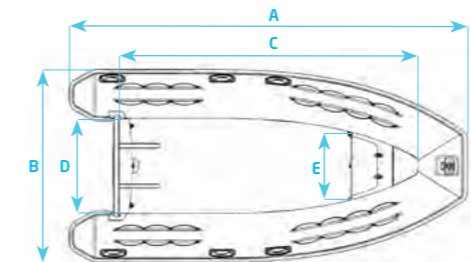

Model	RIB 415	RIB 390	RIB 360	RIB 325	RIB 300	RIB 280	RIB 260
A Overall length (cm)	415	390	360	325	300	280	260
B Overall beam (cm)	187	186	156	156	155	140	140
C Inside length (cm)	289	272	255	225	195	193	177
D Inside beam (cm)	89	86	68	68	68	63	62
E Bow locker width (cm)	-	-	-	-	-	-	-
F Stern height (cm)	63	58	58	52	51	45	44
G Bow height (cm)	103	103	89	87	85	81	77
Total weight (Kg)	89	69	57	42	37	35	35
Max. passengers	8	7	6	6	5	4	4
Max load (Kg)	860	700	650	500	450	350	300
Tube (cm)	50	45	45	42	42	36	36
Number of airtight chambers	3	3	3	3	3	3	3
Shaft	Long	Long	Long	Short	Short	Short	Short
Max. power	25 HP	25 HP	25 HP	20 HP	15 HP	15 HP	10 HP
Front locker	Standard	Standard	Standard	*	*	*	*
Bow roller	Standard	Standard	Standard	Standard	Standard	Standard	Standard
Console & seat	Option 1	Option 1	Option 1	Option 1	-	-	-
PVC Melher tech. valmex	Price 2 990 €	2 590 €	2 490 €	2 290 €	1 990 €	1 650 €	1 590 €
Hypalon Orca Pennel & Flipo	Price 4 990 €	4 423 €	4 140 €	3 090 €	2 790 €	2 290 €	2 090 €

All prices are presented inclusive of VAT * Standard only on Hypalon Orca models

Make and model filed with WIPO and INPI (hull and deck plan, console and forceps, stainless steel seat). Prices and technical data subject to change without notice.

ULTRA LIGHT

RIB Aluminium



30 TENDER[®]
HIGH PERFORMANCE RESEARCH & DEVELOPMENT



ULTRA LIGHT RIB Aluminium

Semi rigid tender with ultra light aluminium hull!

The **Ultra Light RIB** range is available in seven models all made of **PVC Mehler Valmex® Technology** (German fabric) thermo-welded or glued hot also available in **Hypalon Orca Pennel & Flipo**.

Very light, with a very pronounced V shape that provides stability and exceptional passing through the waves and a navigation dry. Hull designed to withstand shock and abrasion associated with rocks, coral and sandy beach. Models above 330 cm are equipped with a front locker to store your nurse.

Incredibly rugged and lightweight!

STANDARD EQUIPMENT

- Fabric PVC Melher technology Valmex® glued or welded seams
- Inflation valves
- Aluminum hull, anti corrosion treated
- Marine paint on aluminum powder
- Anchor well on all hypalon models and on PVC models from 330 cm
- Front locker from 310 cm
- U-bolts of lifting and towing integrated to the hull
- Marine anti-skid surface, UV resistant
- Ultra wide band chafing
- Protection bow
- Aluminum bench
- Bag under bench
- Pump, oars, repair kit



Front locker
On all hypalon models and on all models from 380 to 310 cm

OPTION

Dinghy wheels
99 € VAT inc.



Launching wheels
269 € VAT inc.



See details on console & accessories page 34 - 35

Available colors:
White, Blue & Red

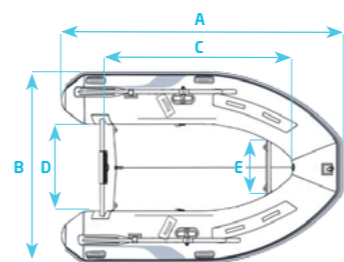

ULTRA LIGHT RIB
290 > 250 CM

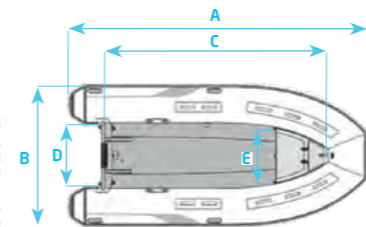

ULTRA LIGHT RIB
380 > 310 CM

Specifications

Model	UL 380	UL 360	UL 330	UL 310	UL 290	UL 270	UL 250
A Overall length (cm)	380	360	330	310	290	270	250
B Overall beam (cm)	186	156	156	154	154	154	154
C Inside length (cm)	267	255	225	205	195	170	156
D Inside beam (cm)	86	68	68	66	66	66	66
E Bow locker width (cm)	67	60	60	-	70	70	70
F Stern height (cm)	57	50	50	-	76	76	76
G Bow height (cm)	108	90	90	-	54	54	54
Total weight (Kg)	69	57	44	34	31	28	24
Max. passengers	7	6	6	5	4	4	3
Max load (Kg)	700	650	500	500	450	450	350
Tube (cm)	45	45	42	42	42	42	42
Number of airtight chambers	3	3	3	3	3	3	3
Shaft	Short	Short	Short	Short	Short	Short	Short
Max. power	25 HP	25 HP	20 HP	15 HP	15 HP	10 HP	8 HP
Front locker	Standard	Standard	Standard	Standard	-	-	-
Bow roller	Standard	Standard	Standard	*	*	*	*
PVC Melher tech. valmex	Price	2 650 €	2 490 €	2 390 €	1 790 €	1 590 €	1 390 €
Hypalon Orca Pennel & Flipo	Price	4 350 €	4 190 €	3 149 €	2 499 €	2 299 €	1 999 €

All prices are presented inclusive of VAT * Standard only on Hypalon Orca models

Make and model filed with WIPO and INPI (hull and deck plan, console and forceps, stainless steel seat). Prices and technical data subject to change without notice.



ALUMINIUM SEMI-RIGID

FAST LINE

Foldable transom

The **Fast Line** has been specially created to facilitate the storage of your tender with its engine. A simple manipulation allows you fold the transom in order that the engine do not exceed from the dimensions of the boat. Your tender can then be easily stored in a trunk or on the deck of your boat.

The hull is built in aluminium with a flat deck to ensure light weight and solidity. The V-shape of the hull also allows good speed and confort in all weather conditions.

STANDARD EQUIPMENT

- Foldable transom
- Fabric PVC Valmex®, Mehler Technologie glued or welded seams
- Inflation valves
- Aluminium hull, anti corrosion treated
- Marine paint on aluminium powder
- U-bolts of lifting and towing integrated to the hull
- Marine anti-skid surface, UV resistant
- Ultra wide band chafing
- Protection bow
- Aluminum bench
- Bag under bench
- Pump, oars, repair kit

OPTION

Dinghy wheels
99 € VAT inc.



Launching wheels
269 € VAT inc.



See details on console & accessories page 34 - 35

Available colors:
White, Blue & Red

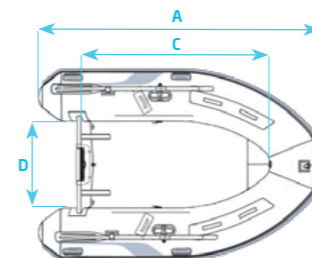

Specifications

Model	FL 240
A Overall length (cm)	240
B Overall beam (cm)	136
C Inside length (cm)	185
D Inside beam (cm)	65
F Stern height (cm)	75
G Bow height (cm)	65
Total weight (Kg)	34
Max. passengers	3
Max load (Kg)	320
Tube (cm)	36
Number of airtight chambers	3
Shaft	Short
Max. power	8 HP
PVC Melher tech. valmex	Prix TTC
	1990 €

All prices are presented inclusive of VAT



25

Make and model filed with WIPO and INPI (hull and deck plan, console and forceps, stainless steel seat). Prices and technical data subject to change without notice.



LUX

Semi rigid tender with aluminium hull, front locker and protective cover in neoprene.

The **LUX** range is composed by 3 models all equipped with a front locker and a removable protective cover in neoprene for tube to ensure an optimal longevity.

Its hull has been designed in aluminium with a pronounced V-shape and a flat deck to offer the perfect balance between lightness, durability and seaworthiness.

- ÉQUIPEMENT STANDARD**
- Fabric PVC Valmex®, Mehler Technologie glued or welded seams
 - White protective cover in neoprene
 - Inflation valves
 - Aluminium hull, anti corrosion treated
 - Marine paint on aluminium powder
 - Anchor well
 - Front locker
 - U-bolts of lifting and towing integrated to the hull
 - Protective rubber
 - Aluminium bench
 - Pump, oars, repair kit

- OPTION**
- Dinghy wheels
99 € VAT inc.
 - Launching wheels
269 € VAT inc.

See details on console & accessories page 34 - 35

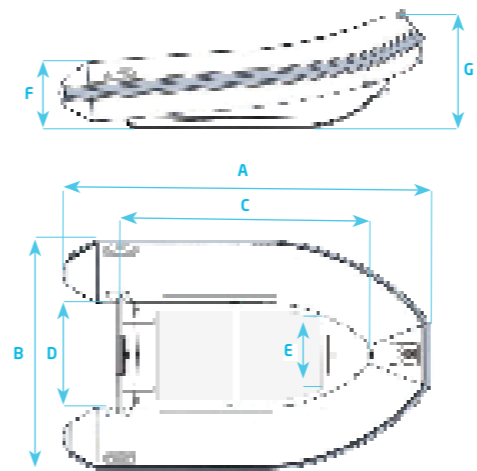

Specifications

Model	LUX 325	LUX 300	LUX 280
A Overall length (cm)	325	300	280
B Overall beam (cm)	156	155	140
C Inside length (cm)	225	195	193
D Inside beam (cm)	68	68	63
E Bow locker width (cm)	-	-	-
F Stern height (cm)	-	-	-
G Bow height (cm)	-	-	-
Total weight (Kg)	43	37	36
Max. passengers	4,5	4	3,5
Max load (Kg)	550	500	450
Tube (cm)	42	42	42
Number of airtight chambers	3	3	3
Shaft	Short	Short	Short
Max. power	15 HP	10 HP	10 HP
Bow locker	Standard	Standard	Standard
Bow roller	Standard	Standard	Standard
PVC Melher tech. valmex	Price	1 990 €	1 590 €
		1 490 €	

All prices are presented inclusive of VAT

Make and model filed with WIPO and INPI (hull and deck plan, console and forceps, stainless steel seat). Prices and technical data subject to change without notice.



3D TENDER[®]
HIGH PERFORMANCE RESEARCH & DEVELOPMENT

FOLDABLE TENDERS

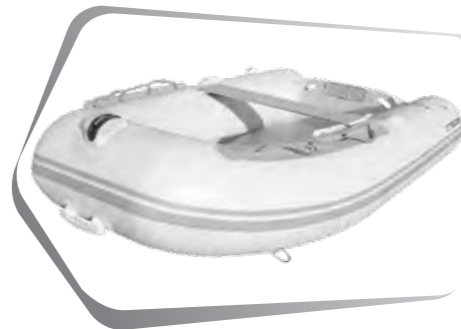

LT 240 Hypalon

Premium foldable tender in Hypalon.

The LT 240 is entirely build with *Hypalon Orca Pennel & Flipo*, A tissu worldwide recognize for its durability and its resistance to UV radiation. This tender is moreover build with a high pressure honeycomb floor to garanty lightness and ease of use.

STANDARD EQUIPMENT

- High pressure inflatable floor with honey-comb construction
- Anchor well
- Aluminium bench
- Oars
- Pump
- Repair kite

Model	LT 240
A Overall length (cm)	240
B Overall beam (cm)	150
C Inside length (cm)	179
D Inside beam (cm)	70
Total weight (Kg)	23
Max. passengers	3
Max load (Kg)	450
Tube (cm)	40
Number of airtight chambers	2+1
Shaft	Court
Max. power	6 HP
Dimensions in bag (cm)	90x45x30
Hypalon Orca Pennel & Flipo	Price
	1 290 €

All prices are presented inclusive of VAT

Make and model filed with WIPO and INPI (hull and deck plan, console and forceps, stainless steel seat). Prices and technical data subject to change without notice.



FROM ONLY
9,6 KG!



FROM ONLY
6,5 KG!



SUPERLIGHT TWIN AIR

3D TENDER developed the **SUPERLIGHT TWIN AIR** range to fit the expectations of pleasure boaters. Its high pressure floor with honeycomb construction as well as the materials used ensure the best balance between superlight weight, durability and ease of use. Storage on transportation are also facilitated, thanks to an adapted backpack.

STANDARD EQUIPMENT

- High pressure inflatable floor with honeycomb construction
- Aluminium bench
- Oars
- Pump
- Repair kite
- Backpack for storage and transport

Available colors:
White & Black

Model	TWA290	TWA270	TWA250	TWA230	TWA200	TWA180	TWA160
A Overall length (cm)	290	270	250	230	200	180	160
B Overall beam (cm)	136	135	135	134	131	129	129
C Inside length (cm)	234	215	195	177	145	126	106
D Inside beam (cm)	67	67	67	66	63	62	61
Total weight (Kg)	16,9	15,8	14,5	13,8	11,9	10,8	9,6
Max. passengers	4	3,5	3	2	2	1,5	1
Max load (Kg)	510	484	450	350	250	200	180
Tube (cm)	34-40	34-40	34-40	32-36	32-35	32-35	30
Number of airtight chambers	3+1	3+1	3+1	2+1	2+1	2+1	2+1
Shaft	Court	Court	Court	Court	Court	Court	Court
Max. power	10 HP	7.5 HP	7.5 HP	4 HP	3.5 HP	3.5 HP	2.5 HP
Dimensions in bag (cm)	98x48x28	98x48x28	98x48x28	90x45x28	90x45x28	90x45x28	90x45x26
PVC Melher tech. valmex	Price	949 €	899 €	799 €	699 €	649 €	599 €

All prices are presented inclusive of VAT

Make and model filed with WIPO and INPI (hull and deck plan, console and forceps, stainless steel seat). Prices and technical data subject to change without notice.

Specifications

SUPERLIGHT TWIN ROUND AIR

The use premium materials extremely light, and the absence of transom was the key elements to design the **SUPERLIGHT TWIN ROUND AIR**, which is the lightest tender available in the market. Once folded, it is also the smallest one to fit in small trunks.

STANDARD EQUIPMENT

- High pressure inflatable floor with honeycomb construction
- Motor support
- Aluminium bench
- Oars
- Pump
- Repair kite
- Backpack for storage and transport

Available colors:
White & Black

Model	TWRA250	TWRA235	TWRA200	TWRA180	TWRA160
A Overall length (cm)	250	235	200	180	160
B Overall beam (cm)	133	133	114,5	101,5	100,5
C Inside length (cm)	178	163	134	123	103
D Inside beam (cm)	61	61	48,5	44,5	43,5
Total weight (Kg)	12,2	11,8	9,2	7	6,5
Max. passengers	3	2	1,5	1	1
Max load (Kg)	400	350	250	200	180
Tube (cm)	36	36	33	28,5	28,5
Number of airtight chambers	2	2	2	2	2
Shaft	Short	Short	Short	Short	Short
Max. power	6 HP	5 HP	3.5 HP	2.5 HP	2 HP
Dimensions in bag (cm)	70x45x32	70x45x32	70x45x30	70x45x27	70x45x26
PVC Melher tech. valmex	Price	749 €	649 €	619 €	569 €

All prices are presented inclusive of VAT

Make and model filed with WIPO and INPI (hull and deck plan, console and forceps, stainless steel seat). Prices and technical data subject to change without notice.

Specifications



FROM ONLY
19 KG!



FROM ONLY
19 KG!



SUPERLIGHT TWIN VIB AIR

With its V-shaped inflatable hull, the **Superlight Twin VIB Air** has been designed for boaters who look for speed and confort especially in difficult weather conditions. une mer formée. The tender is delivered with 2 disposable protective covers in neoprene, One black and one white, you can easily change the color of your boat.

STANDARD EQUIPMENT

- High pressure inflatable floor with honey-comb construction
- 2 protective cover in neoprene
- Aluminium bench
- Oars
- Pump
- Repair kite
- Backpack for storage and transport

Specifications

Model	TwVA330	TwVA300	TwVA280	TwVA250	TwVA210	
A Overall length (cm)	330	300	280	250	210	
B Overall beam (cm)	153	153	153	150	131	
C Inside length (cm)	-	-	-	-	-	
D Inside beam (cm)	-	-	-	-	-	
Total weight (Kg)	34	29	25	22	19	
Max. passengers	4,5	4	4	3	2	
Max load (Kg)	566	510	500	450	250	
Tube (cm)	42	42	42	42	36	
Number of airtight chambers	3+1	3+1	3+1	2+1	2+1	
Shaft	Short	Short	Short	Short	Short	
Max. power	15 HP	10 HP	10 HP	6 HP	3.5 HP	
Dimensions in bag (cm)	90x45x40	90x45x35	90x45x32	90x45x30	90x45x28	
PVC Melher tech. valmex	Price	1 390 €	1 090 €	990 €	890 €	790 €

All prices are presented inclusive of VAT

Make and model filed with WIPO and INPI (hull and deck plan, console and forceps, stainless steel seat). Prices and technical data subject to change without notice.

WORLD TRAVEL

3D TENDER developped his range to fit the expectations of pleasure boaters. His conical tubes bring a maximum of floatability. the storage and transportation are also facilitated, thanks to the adapted backpack.

STANDARD EQUIPMENT

- Slatted floor
- Aluminium bench
- Oars
- Pump
- Repair kite
- Backpack for storage and transport

Specifications

Model	WT235	WT200	
A Overall length (cm)	235	200	
B Overall beam (cm)	131	131	
C Inside length (cm)	183	147	
D Inside beam (cm)	60	60	
Total weight (Kg)	21	19	
Max. passengers	3	3	
Max load (Kg)	350	350	
Tube (cm)	37-32	37-32	
Number of airtight chambers	2	2	
Shaft	Short	Short	
Max. power	4 HP	4 HP	
Dimensions in bag (cm)	98x49x35	98x49x35	
PVC Melher tech. valmex	Price	349 €	319 €

All prices are presented inclusive of VAT

Make and model filed with WIPO and INPI (hull and deck plan, console and forceps, stainless steel seat). Prices and technical data subject to change without notice.

OPTION ANNEXES PLIABLES

Dinghy wheels
99 € VAT inc.



3D TENDER ACCESSORIES



SEAT - REAR TRUNK	L	XL
Length (cm)	80	92
Beam (cm)	50	52
Height (cm)	90	90
Price VAT inc.	549 €	749 €

L for PATROL 530, 550 - XPRO 535, 490, 445, 420.
XL for PATROL 650, 600 - XPRO 589.



JOCKEY SEAT	
Length (cm)	53
Beam (cm)	35
Height (cm)	96
Price VAT inc.	447 €

For PATROL & XPRO RIB all sizes.



BOLSTER SEAT	L	XL
Length (cm)	80	95
Beam (cm)	40	35
Height (cm)	85	98
Price VAT inc.	549 €	610 €

Standard on : L on PATROL 600, 550 & XPRO 589.
XL on PATROL 650.



CONSOLE - FRONT TRUNK	L	XL
Length (cm)	105	90
Beam (cm)	70	82
Height (cm)	140	140
Price VAT inc.	1 125 €	1 299 €

L : Standard on PATROL 600, 550, option on XPRO 589.
XL : Standard on PATROL 650



CONSOLE	
Length (cm)	83
Beam (cm)	62
Height (cm)	149
Price VAT inc.	790 €

Standard on : PATROL 530 & 560.



JOCKEY CONSOLE	
Length (cm)	135
Beam (cm)	50
Height (cm)	90
Price VAT inc.	879 €

Pour XPRO RIB 360, 390, 415, 420, 445, 490.



PILOTE SEAT	
Length (cm)	46
Beam (cm)	98
Height (cm)	120
Price VAT inc.	1 490 €



LINING POST	
Length (cm)	42
Beam (cm)	50
Height (cm)	83
Price VAT inc.	590 €

Standard on PATROL 530 & 560.



GLACIÈRE	
Length (cm)	40
Beam (cm)	72
Height (cm)	42,5
Price VAT inc.	139 €



ROLL BAR
For : PATROL all sizes
299 € VAT inc.



ROLL BAR
For : XPRO 589, 535, 490, 445
699 € VAT inc.



TIP TOP
aluminium
1 390 € VAT inc.



ROLL BAR SEAT
For : XPRO 535, 490, 445
990 € VAT inc.



FISHING ROD HOLDER
For : Roll bar & Tip top
Simple **69 € VAT inc.**
Double **99 € VAT inc.**

DINGHY WHEELS
99 € VAT inc.



LAUNCHING WHEELS
269 € VAT inc.



Make and model filed with WIPO and INPI (hull and deck plan, console and forceps, stainless steel seat). Prices and technical data subject to change without notice.



PACK BOAT + MOTOR

Prices for information purpose only, may change without notice

PRICE VAT INCLUDED



FOLDABLE ALUMINIUM

MODEL	BOAT ONLY	BOAT + 2,5 HP	BOAT + 6 HP	BOAT + 15 HP	BOAT + 20 HP
XPRO Heavy Duty 320	1 490 €	2 157 €	2 699 €	4 634 €	-
XPRO Heavy Duty 360	1 690 €	2 315 €	2 856 €	4 791 €	4 956 €
XPRO Heavy Duty 380	1 790 €	-	2 943 €	4 878 €	5 043 €
XPRO Heavy Duty 420	1 990 €	-	3 239 €	5 174 €	5 339 €
XPRO Heavy Duty 460	2 290 €	-	3 386 €	5 321 €	5 486 €
XPRO Heavy Duty 500	2 720 €	-	3 765 €	5 700 €	5 865 €
XPRO Heavy Duty 550	2 990 €	-	4 178 €	6 113 €	6 278 €
PATROL 380	1 990 €	-	3 230 €	5 165 €	5 330 €
PATROL 425	2 290 €	-	3 510 €	5 445 €	5 610 €
PATROL 475	2 490 €	-	3 699 €	5 634 €	5 799 €

FOLDABLE TENDERS

MODEL	TENDER ONLY	TENDER+ 2,5 HP	TENDER + 6 HP	TENDER + 15 HP	TENDER + 20 HP
TWIN AIR 160	549 €	1 340 €	-	-	-
TWIN AIR 180	599 €	1 388 €	-	-	-
TWIN AIR 200	649 €	1 433 €	-	-	-
TWIN AIR 230	699 €	1 481 €	-	-	-
TWIN AIR 250	799 €	1 575 €	2 117 €	-	-
TWIN AIR 270	899 €	1 668 €	2 210 €	-	-
TWIN AIR 290	949 €	1 716 €	2 258 €	-	-
TWIN ROUND AIR 160	505 €	1 298 €	-	-	-
TWIN ROUND AIR 180	569 €	1 359 €	-	-	-
TWIN ROUND AIR 200	619 €	1 406 €	-	-	-
TWIN ROUND AIR 235	649 €	1 432 €	-	-	-
TWIN ROUND AIR 250	749 €	1 527 €	2 069 €	-	-
TWIN VIB AIR 210	790 €	1 556 €	-	-	-
TWIN VIB AIR 250	890 €	1 661 €	2 202 €	-	-
TWIN VIB AIR 280	990 €	1 754 €	2 295 €	-	-
TWIN VIB AIR 300	1 090 €	1 848 €	2 390 €	-	-
TWIN VIB AIR 330	1 390 €	2 130 €	2 672 €	4 607 €	-
WORLD TRAVEL 200	319 €	1 124 €	-	-	-
WORLD TRAVEL 235	349 €	1 154 €	-	-	-
LT Hypalon 240	1 290 €	2 087 €	2 628 €	-	-

ALUMINIUM SEMI-RIGID

MODEL	TENDER ONLY	TENDER + 2,5 HP	TENDER + 6 HP	TENDER + 15 HP	TENDER + 20 HP
XPRO RIB Alu 260 - PVC	1 590 €	2 319 €	2 861 €	-	-
XPRO RIB Alu 260 - Hypalon	2 090 €	2 828 €	3 369 €	-	-
XPRO RIB Alu 280 - PVC	1 650 €	2 375 €	2 916 €	4 851 €	-
XPRO RIB Alu 280 - Hypalon	2 290 €	2 993 €	3 534 €	5 469 €	-
XPRO RIB Alu 300 - PVC	1 990 €	2 695 €	3 236 €	5 171 €	-
XPRO RIB Alu 300 - Hypalon	2 790 €	3 470 €	4 011 €	5 946 €	-
XPRO RIB Alu 325 - PVC	2 290 €	2 982 €	3 524 €	5 459 €	5 624 €
XPRO RIB Alu 325 - Hypalon	3 090 €	3 738 €	4 280 €	6 215 €	6 380 €
XPRO RIB Alu 360 - PVC	2 490 €	3 165 €	3 707 €	5 642 €	5 807 €
XPRO RIB Alu 360 - Hypalon	4 140 €	4 728 €	5 270 €	7 205 €	7 370 €
XPRO RIB Alu 390 - PVC	2 590 €	-	3 963 €	5 898 €	6 063 €
XPRO RIB Alu 390 - Hypalon	4 423 €	-	5 538 €	7 473 €	7 638 €
XPRO RIB Alu 415 - PVC	2 990 €	-	4 335 €	6 270 €	6 435 €
XPRO RIB Alu 415 - Hypalon	4 990 €	-	6 072 €	8 007 €	8 172 €
XPRO RIB Alu renforcé 390 - PVC	3 990 €	-	5 256 €	7 191 €	7 356 €
XPRO RIB Alu renforcé 390 - Hypalon	5 990 €	-	7 206 €	9 141 €	9 306 €
XPRO RIB Alu renforcé 420 - PVC	4 490 €	-	5 744 €	7 679 €	7 844 €
XPRO RIB Alu renforcé 420 - Hypalon	6 490 €	-	7 694 €	9 629 €	9 794 €

MODEL	TENDER ONLY	TENDER + 2,5 HP	TENDER + 6 HP	TENDER + 15 HP	TENDER + 20 HP
ULTRA LIGHT 250 - PVC	1 390 €	2 127 €	2 669 €	-	-
ULTRA LIGHT 250 - Hypalon	1 899 €	2 675 €	3 216 €	-	-
ULTRA LIGHT 270 - PVC	1 490 €	2 220 €	2 761 €	-	-
ULTRA LIGHT 270 - Hypalon	1 999 €	2 772 €	3 314 €	-	-
ULTRA LIGHT 290 - PVC	1 590 €	2 315 €	2 856 €	4 791 €	-
ULTRA LIGHT 290 - Hypalon	2 299 €	3 065 €	3 606 €	5 541 €	-
ULTRA LIGHT 310 - PVC	1 790 €	2 502 €	3 044 €	4 979 €	-
ULTRA LIGHT 310 - Hypalon	2 499 €	3 260 €	3 801 €	5 736 €	-
ULTRA LIGHT 330 - PVC	2 390 €	3 065 €	3 606 €	5 541 €	5 706 €
ULTRA LIGHT 330 - Hypalon	3 149 €	3 894 €	4 436 €	6 371 €	6 536 €
ULTRA LIGHT 360 - PVC	2 490 €	3 158 €	3 699 €	5 634 €	5 799 €
ULTRA LIGHT 360 - Hypalon	4 190 €	4 910 €	5 451 €	7 386 €	7 551 €
ULTRA LIGHT 380 - PVC	2 650 €	-	3 950 €	5 885 €	6 050 €
ULTRA LIGHT 380 - Hypalon	4 350 €	-	5 607 €	7 542 €	7 707 €
FAST LINE 240 - PVC	1 990 €	2 690 €	3 231 €	-	-
FAST LINE 240 - Hypalon	2 690 €	3 345 €	3 886 €	-	-
LUX 280	1 490 €	2 317 €	2 859 €	-	-
LUX 300	1 590 €	2 418 €	2 960 €	-	-
LUX 325	1 990 €	2 820 €	3 362 €	5 297 €	-

RETAILERS :

FRANCE

3D TENDER INTERNATIONAL FACTORY (IMPORTATEUR)

50 rue des Mouettes - BP 20036 - 29801 Brest cedex 09
Tel. (+33) 06 81 31 19 36 - international@3dtender.com

ACCASTILLAGE DIFFUSION CANET

Zone Technique Portuaire - 66140 Canet en Roussillon
Tel. (+33) 04 68 80 60 66

AGENT POUR LA CORSE ISOLEA LOCATION

Anse Cala Medea - 20166 Rupionne
Tel. (+33) 06 28 03 67 57

ARMOR LOC SERVICE

Allée des Ecoreuils - route de Iorient - 56260 Larmor Plage
Tel. (+33) 02 40 23 64 94 - Mob. (+33) 06 64 45 40 70

ATLANTIC BATEAU PIRIAC

440 route Clos du Moulin - ZA du Pladreau - 44420 Piriac-sur-Mer
Tel. (+33) 02 40 23 64 94 - Mob. (+33) 06 64 45 40 70

BOIS & YACHTING

26 zone technique portuaire - 11430 Gruissan
Tel. (+33) 04 68 32 20 41

BRICE SPORTS NAUTIQUE

59/61 RN 7 - 91350 Grigny
Tel. (+33) 01 69 06 99 09

BRETAGNE MARINE

15 quai Pierre Loti - 22500 Paimpol
Tel. (+33) 02 96 55 36 40 - Mob. (+33) 06 82 68 55 15

BULLIT MOTORS

38 rue Hélène Boucher - 22190 Plerin
Tél. 02 96 74 72 05

CAP LOISIR

Port Chantereyne - 50100 Cherbourg
Tel. (+33) 02 33 87 58 20

CANCALE NAUTIC

7 rue du Brocanteur - 35260 Cancale
Tel. (+33) 07 60 16 19 63

CONCAR'NAUTIC

6, rue Moros - 29900 Concarneau
Tel. (+33) 02 98 97 40 37

CRAS NAUTIQUE

Rue de Roche Garde - ZA des Islandais - 22680 Étables-Sur-Mer
Tel. (+33) 02 96 70 57 83

DB MARINE

25 rue du Lac - 22400 Cap-Frehel
Tel. (+33) 02 96 41 42 32

ELECTRO-NAUTIC S.A.

23, RUE RASPAIL - BP 385 - 97162 Pointe-à-Pitre
Tel. (+33) 05 90 21 36 77

ELLIAN MARINE

Le port - 1 Impasse des Carrelets - 17132 Meschers-sur-Gironde
Tel. (+33) 05 46 22 57 09 - Mob. (+33) 06 89 21 06 47

ESPACE YAM

Route Plage Napoléon - 13320 Port Saint-Louis-du-Rhône
Tel. 04 42 48 48 48

EVASION MARINE

Quai de la Pêche - ZT du port - 40130 Capbreton
Tel. (+33) 05 58 72 29 89

GELGON NAUTISME

12 rue de Lannion - 22710 Penvenan
Tel. (+33) 02 96 92 67 00

GUYANE SERVICE SURVIE

ZI de Dégrad des Cannes - 97354 Rémire Montjoly
Tel. (+33) 05 94 29 07 64

KENKIZ

ZA des 4 chemins - 56550 Belz
Tel. (+33) 02 97 55 33 55

MK BOATS

1985 RN96 Napollon - 13400 Aubagne
Tel. (+33) 06 21 80 11 65

NAUTIC DU GOLFE MORBIHAN

Le Sclégen - 56950 Crac'h
Tel. (+33) 06 89 50 60 07

NAVI OUEST

700 rue Alain Colas - Port du Moulin Blanc - 29200 Brest
Tel. (+33) 02 98 33 12 12

OK GLISSE

Rue Antoine Becquerel - 21300 Chenove
Tel. (+33) 03 80 52 24 06

QUAI OUEST MARINE

6 Quai Ouest - 14470 Courseulles-sur-mer
Tel. (+33) 02 31 37 42 34

SEUDRE OLERON MARINE

ZA les Grossines - 17320 Marennes
Tel. (+33) 05 46 85 20 36

SPRM CAP'NAUTIC

11 rue de la République - Z.I. République Nord - 86000 Poitiers
Tel. (+33) 05 49 37 23 02

TERRITOIRE PECHE 77

57 rue Jacquard - 77400 Lagny-sur-Marne
Tel. (+33) 09 80 31 25 75

VENDEE PLAISANCE

298 route des sables - 85160 Saint-Jean-de-Monts
Tel. (+33) 02 51 59 33 95 - Mob. (+33) 06 18 92 54 66

NEW CALEDONIA

PACIFIC BREIZH TENDER

24, rue Louis Henin - 98800 Nouméa
Tel. (+687) 74 18 31

UNITED KINGDOM

FORCE 4 CHANDLERY

Unit 17, Spring Mill Industrial Estate Avening Road - GL6 OBS - Nailsworth
Gloucestershire

Tél. (+44) 01243 514755

MARINE SUPERSTORE - BIRDHAM

Unit D7 Chichester Marina - PO20 7EJ Birdham - Chichester
Tél. (+44) 01243 514755

MARINE SUPERSTORE - PORTSMOUTH

7 - 11 The Slipway - PO6 4TR Port Solent - Portsmouth
Tél. (+44) 02392 219433

PROMARINE UK LTD

Unit 6 Tamar Building - QAB Marine - PL4 OLP Plymouth
Tél. (+44) 01752 267984

SEAMARK NUNN LTD

400 High Road - IP11 0UQ
Tél. (+44) 01394 451000



3D TENDER®
 HIGH PERFORMANCE RESEARCH & DEVELOPMENT

50 rue des Mouettes - BP 20036 - 29801 Brest cedex 09 - France

More informations on :

WWW.3DTENDER.COM

Or contact our advisor: Mr Olivier DALIDEC
 (+33) 06 81 31 19 36 - international@3dtender.com

