

3D TENDER[®]

HIGH PERFORMANCE RESEARCH & DEVELOPMENT



PRODUCT CATALOG 2016 - ENGLISH

HIGH QUALITY 3D TENDER

3D TENDER[®]
HIGH PERFORMANCE RESEARCH & DEVELOPMENT

Semi-rigid polyester hull, aluminum hull, removable floors, ultra-lightweight dinghies with high pressure inflatable hull... The 3D TENDER range offers unrivaled choice of models to value / price on the market

ENVIRONMENT

We pay a great attention to the respect of the environment during the production of 3D Tender boats. We make sure to use non-polluting process, energy economic respecting the health of employees and users. The choice of raw materials is also crucial since it allows to build very strong but also close to nature boats.

FEATHERWEIGHT 3D TENDER

The aluminum hull boats bring their strength while giving them an unbeatable advantage in terms of weight. These boats can be powered by small engines, cheaper, more fuel efficient, reducing their CO₂ emissions.

ALUMINIUM 3D TENDER

Aluminum is one of the only materials that can be recycled so without losing its unlimited qualities and properties .

3D Tender chose to use powder paint. These powders are electrically charged and are sprayed onto the prepared surfaces before placing in the oven. The finish is impeccable, the painted surfaces are smooth and shiny.

The powder paints bring considerable advantages compared to paintings conventional liquid:

- No volatile organic mixture
- No solvent (no disk of the sun , pollution, etc...)
- No pollution, excess powder is easily collected by suction

Time and curing temperature were significantly improved in order to reduce energy consumption of the process.

TESTS CONDUCTED ON PAINTING

- Adhesion of primer (BS EN 12206-1)
- Thickness of coatings (ISO 2178)
- Grip paint / support (ISO 2409 and ISO 4624)
- Accelerated UV (ISO 11507)
- Accelerated salt spray (ISO 9227)
- Resistance to impact (ISO 6272)

TESTS CONDUCTED ON TISSUES AND ASSEMBLIES

- Mechanical properties (ISO 1421, ISO 4674 and ISO 2411)
- Assemblies Resistance to heat (ISO 6185)
- Sealed floats (ISO 6185)
- Accelerated UV (ISO 4892)



PATROL

LIMITED EDITION



3D TENDER[®]
HIGH PERFORMANCE RESEARCH & DEVELOPMENT

Patrol Limited edition

With the success of the PATROL range, which is highly regarded for its performance in all conditions, 3D TENDER decided this year to develop this range by designing four different models all available in five sizes, from 530 to 650 cm, in order to satisfy everybody's needs.

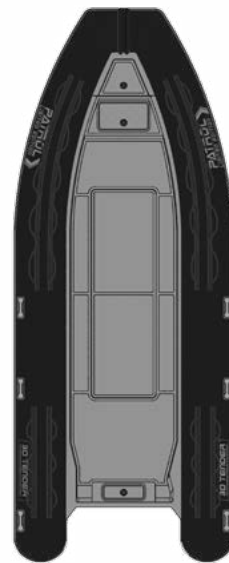

BLACK
PVC Melher Black

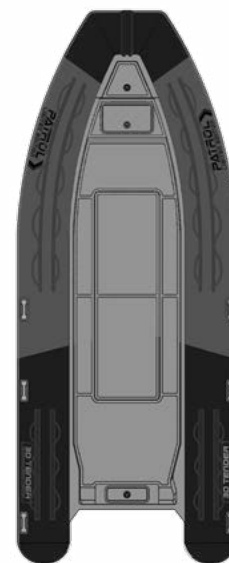

HYPALON
Hypalon Orca

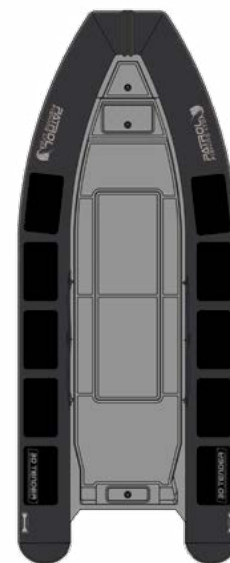

FISHING
PVC Melher Grey

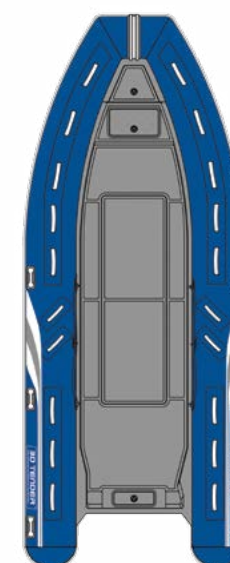

FAMILY
PVC Melher Blue

Four models available in five sizes:
530 - 550 - 560 - 600 - 650 (cm)

PATROL 650 HYPALON - with Jockey Seat Wings



PATROL 600 PVC FISHING - with Roll Bar



PATROL 550 PVC BLACK - with Roll Bar & Seat - Rear Trunk XL



PATROL 550 HYPALON - with Seat - Rear Trunk XL



Patrol Limited edition

The **Patrol Limited edition** are considered as the elite of semi-rigid in our range. It comes in 5 sizes all made of **PVC Mehler Valmex® Technology** (German fabric) thermo-welded or glued hot also available in **Hypalon Orca Pennel & Flipo**.

Thanks to the study of specific environmental constraints and research performance, the **Patrol Limited edition** was developed for professionals who want a boat to all events, tailored precisely to their requirements and needs.

Outsized reliability, with unmatched performance and capacity without limit.

Range suitable for Special Forces, rescue organizations, but also offshore industries, integration on yachts or expeditions and adventures).

STANDARD EQUIPMENT

- Fabric PVC Mehler technology Valmex® glued
- Anchor well
- Front box
- Lifting points & towing eyes
- Anti-slip deck
- Double Heavy duty rubbing strake
- Length keel guard
- Pump, paddles & repair kit
- Console & driver seat
- Double lifelines
- Carry handles
- Reinforcement of cones
- Retractable Cleat
- Pump, Repair kit

CONSOLE ET SEAT

PATROL 650:

Console XL
+ Bolster seat XL



PATROL 600 & 550:

Console L
+ Bolster seat L



PATROL 530:

Console
+ Lining post



See details of console and accessories page 36 - 37

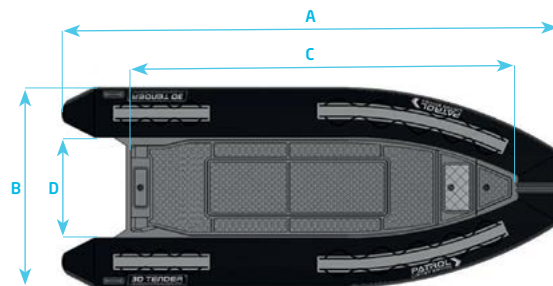

Specifications

Model	PATROL 650	PATROL 600	PATROL 560	PATROL 550	PATROL 530
A Overall length (cm)	650	600	560	550	530
B Overall beam (cm)	250	240	220	240	220
C Inside length (cm)	530	475	430	430	403
D Inside beam (cm)	150	142	120	123	120
Total weight (Kg)	450	350	280	290	230
Max. passengers	15	13	10	11	9
Tube (cm)	57	57	49	57	49
Number of airtight chambers	6	5	5	6	5
Shaft	Long	Long	Long	Long	Long
Max. power	150 HP	135 HP	100 HP	115 HP	90 HP
Front locker	Standard	Standard	Standard	Standard	Standard
Fuel tank capacity	Option	Option	Option	Option	Option
Console & Seat pilot	Standard	Standard	Standard	Standard	Standard
PVC Mehler tech. valmex	Price	11 999 €	10 999 €	8 499 €	8 999 €
Hypalon Orca Pennel & Flipo	Price	14 999 €	13 999 €	10 499 €	10 399 €

All prices are presented inclusive of VAT without transportation costs

Make and model filed with WIPO and INPI (hull and deck plan, console and forceps, stainless steel seat). Prices and technical data subject to change without notice.



LUX

Our range of semi-rigid LUX as been studied to offer a maximum comfort in a boat that remain, sporty, elegant and perfectly adapted to family. Everything have been carefully calculated, from the deep V-hull that offer comfort and maneuverability, to the outstanding standard equipment.

Every models of the LUX range are delivered with a large sunbathing area and a removable picnic table. The rear seat is also modular with a «stand up» or «seat down» position, a perfect combination between confort and space saving.

STANDARD EQUIPMENT

- Fabric PVC Melher technology Valmex®
- Self-bailing deck
- Sunbathing area
- Bow roller
- Console
- Modular rear seat
- Fuel tank
- Picnic table
- Bow locker
- Lifting points & towing eyes
- Anti-slip deck
- Double Heavy duty rubbing strake
- Bow protection
- Pump, Repair kit



Removable Picnic table
Sunbathing area



Modular rear seat
Stand up & seat down

Available colors :



Red



Blue



Black

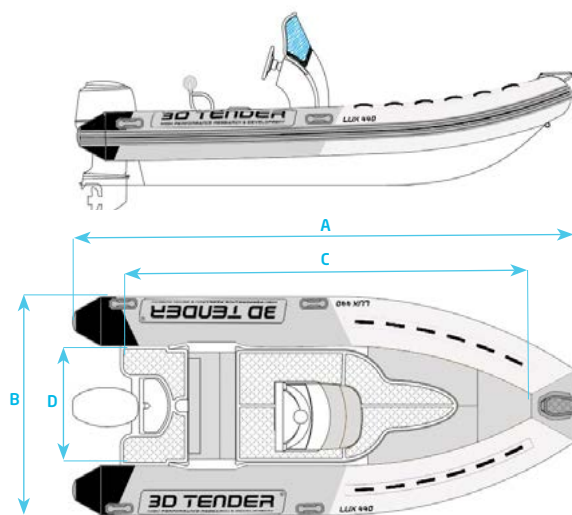

Specifications

Model	LUX 550	LUX 500	LUX 440
A Overall length (cm)	550	500	440
B Overall beam (cm)	224	222	193
C Inside length (cm)	-	-	-
D Inside beam (cm)	-	-	-
Total weight (Kg)	350	300	280
Max. passengers	9	8	7
Tube (cm)	46 / 52	46 / 52	46 / 52
Number of airtight chambers	5	5	3
Shaft	Long	Long	Long
Max. power	90 HP	80 HP	60 HP
Front locker	Standard	Standard	Standard
Fuel tank capacity	60 L	80 L	80 L
Console & Seat pilot	Standard	Standard	Standard
PVC Melher tech. valmex	Price	10 290 €	9 650 €
Hypalon Orca Pennel & Flipo	Price	NC	NC
		7 990 €	NC

All prices are presented inclusive of VAT without transportation costs

Make and model filed with WIPO and INPI (hull and deck plan, console and forceps, stainless steel seat). Prices and technical data subject to change without notice.

XPRO



3D TENDER[®]
HIGH PERFORMANCE RESEARCH & DEVELOPMENT



XPRO

The **XPRO** range includes 6 models all made of **PVC Mehler Valmex® Technology** (German fabric) thermo-welded or glued hot also available in **Hypalon Orca Pennel & Flipo**.

Range completely modular, upgrade your boat according to your wishes and needs (driver seat, console and accessories are placed where you want). Fast boats, stable and easy to handle.

The range is ideal for fishing and family, the best quality / price ratio!

STANDARD EQUIPMENT

- Fabric PVC Melher technology Valmex® glued or welded seams
- Anchor well
- Front box
- Lifting points & towing eyes
- Anti-slip deck
- Double Heavy duty rubbing strake
- Length keel guard
- Pump, paddles & repair kit
- Cover entire wintering
- Console & driver seat
- Double lifelines
- Carry handles
- Reinforcement of cones
- Pump, Repair kit

CONSOLE & SEAT INCLUDED

XPRO 589 & 535:

Console + Bolster seat



XPRO 490 & 445:

Console + Seat



OPTION XPRO in replacement of the standard equipment

XPRO 589:

Console L + Bolster seat L
+ 1 399 €^{VAT inc.}



XPRO 535, 490 & 445:

Console + Bolster seat
+ 599 €^{VAT inc.}

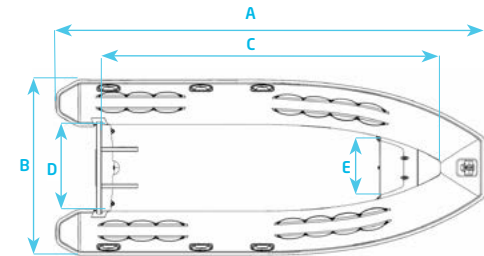

Available colors :

Hypalon Light Grey
 Neptune Grey

PVC White (on demand)
 Dark Grey
 Black

Specifications

Model	XPRO 589	XPRO 535	XPRO 490	XPRO 445
A Overall length (cm)	589	535	490	445
B Overall beam (cm)	252	212	208	208
C Inside length (cm)	472	368	335	303
D Inside beam (cm)	133	101	101	101
E Bow locker width (cm)	84	80	-	-
F Stern height (cm)	127	119	114	112
G Bow height (cm)	83	73	72	72
Total weight (Kg)	400	234	178	167
Max. passengers	16	10	7	7
Max load (Kg)	1 800	1 350	880	800
Tube (cm)	57	52	52	52
Number of airtight chambers	6	6	6	6
Shaft	Long	Long	Long	Long
Max. power	120 HP	75 HP	60 HP	50 HP
Front locker	Standard	Standard	Standard	Standard
Fuel tank storage	Option 58 L	Option 58 L	Option 58 L	Option 58 L
Console & seat	Standard	Standard	Standard	Standard
PVC Melher tech. valmex Price	8 999 €	6 499 €	5 499 €	4 999 €
Hypalon Orca Pennel & Flipo Price	10 999 €	8 499 €	7 499 €	6 999 €

All prices are presented inclusive of VAT without transportation costs

See details on console & accessories

page 36 - 37

Make and model filed with WIPO and INPI (hull and deck plan, console and forceps, stainless steel seat). Prices and technical data subject to change without notice.



XPRO Heavy Duty

The **XPRO Heavy Duty** range is available in seven models all made in **1600 decitex PVC** thermo-welded or glued hot and offers an inflatable V-shaped hull with a removable aluminum floor.

This range offers an excellent compromise between comfort and safety, a quick start and a surprising interior space.

Comfortable and versatile boat for excursions, fishing trips or diving fabulous.

Partner at all times!

STANDARD EQUIPMENT

- Fabric PVC 1600 Decitex glued or welded seams
- Anchor well
- Cover entire wintering
- 2 adjustable benches
- 2 oars
- 2 carrying bags
- 2 storage bags under the bench
- Pump
- Repair kit

OPTIONS XPRO HEAVY DUTY

Dinghy wheels
99 € VAT inc.



Launching wheels
269 € VAT inc.

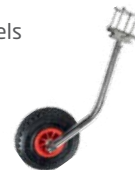

See details on console & accessories

page 36 - 37

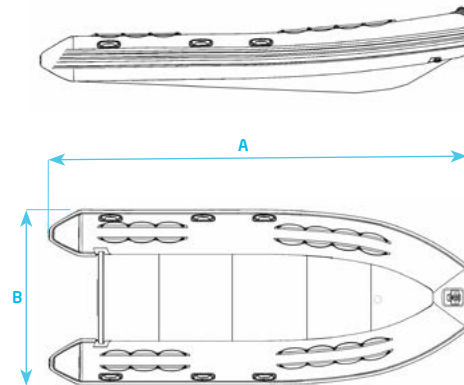

Specifications

Model	HD 550	HD 500	HD 460	HD 420	HD 380	HD 360	HD 320
A Overall length (cm)	550	500	460	420	380	360	320
B Overall beam (cm)	208	193	190	190	170	168	141
Total weight (Kg)	130	118	98	88	78	68	56
Max. passengers	10	9	8	7	6	5	5
Max load (Kg)	1300	1200	1100	1087	727	689	566
Tube (cm)	55	55	50	50	45	45	42
Number of airtight chambers	4+1	4+1	4+1	3+1	3+1	3+1	3+1
Shaft	Long	Long	Short	Short	Short	Short	Short
Max. power	45 HP	45 HP	40 HP	30 HP	20 HP	20 HP	25 HP
Dimensions en bag (cm)	149x79x49	133x69x39	133x69x39	131x66x39	121x66x38	107x66x38	107x66x38
PVC	Price	3 099 €	2 829 €	2 399 €	2 099 €	1 899 €	1 599 €

All prices are presented inclusive of VAT without transportation costs

Make and model filed with WIPO and INPI (hull and deck plan, console and forceps, stainless steel seat). Prices and technical data subject to change without notice.

XPRO

RIB Aluminium



3D TENDER[®]
HIGH PERFORMANCE RESEARCH & DEVELOPMENT



XPRO RIB Aluminium

The XPRO RIB range includes 7 models all made of PVC Mehler Valmex® Technology (German fabric) thermo-welded or glued hot also available in Hypalon Orca Pennel & Flipo.

Combining a sporty and elegant design XPRO RIB is ideal for those who need a comfortable, lightweight boat. Each model is equipped with a rugged aluminum hull with a double floor and a front locker for storing the nurse (360, 390, 415).

These boats can achieve a good cruising speed with small engines and offer an important and significant fuel economy

STANDARD EQUIPMENT

- Fabric PVC Melher technology Valmex® glued or welded seams
- Inflation valves
- Aluminum hull, anti corrosion treated
- Marine paint on aluminum powder
- Anchor well
- Front locker from 360 cm
- U-bolts of lifting and towing integrated to the hull
- Slip coating UV resistant marine
- Ultra wide band chafing
- Protection bow
- Double References
- Aluminum bench slide
- Pump, oars, repair kit



Front locker
On all hypalon models and on all models from 415 to 360 cm

Option 1
Jockey console
999 € VAT inc.



Dinghy wheels
99 € VAT inc.



Launching wheels
269 € VAT inc.



See details on console & accessories page 36 - 37

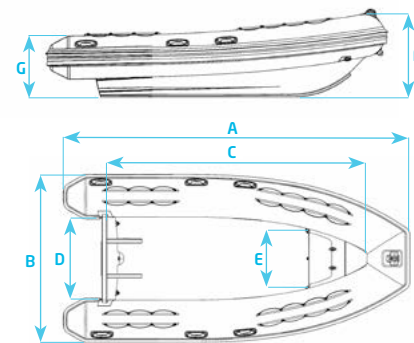

Available colors :

- Light Grey for : RIB 260, 280, 300, 325
- Neptune Grey for : RIB 325, 360, 390, 415, XPRO 390, 420
- Light Grey for : RIB 260, 280, 300, 325
- Dark Grey for : RIB 325, 360, 390, 415, XPRO 390, 420
- Black for : XPRO 390, 420

Specifications

Model	RIB ALUMINIUM REINFORCED							RIB ALUMINIUM REINFORCED		
	RIB 415	RIB 390	RIB 360	RIB 325	RIB 300	RIB 280	RIB 260	XPRO 420	XPRO 390	
A Overall length (cm)	415	390	360	325	300	280	260	420	390	
B Overall beam (cm)	187	186	156	156	155	140	140	187	186	
C Inside length (cm)	289	272	255	225	195	193	177	293	272	
D Inside beam (cm)	89	86	68	68	68	63	62	89	86	
E Bow locker width (cm)	-	-	-	-	-	-	-	-	-	
F Stern height (cm)	103	103	89	87	85	81	77	103	103	
G Bow height (cm)	63	58	58	52	51	45	44	67	58	
Total weight (Kg)	89	69	57	42	37	35	35	128	113	
Max. passengers	8	7	6	6	5	4	4	8	7	
Max load (Kg)	860	700	650	500	450	350	300	900	700	
Aluminium Thickness (mm)	2,5 / 3	2,5 / 3	2,5 / 3	2,5 / 3	2,5 / 3	2,5 / 3	2,5 / 3	4 / 5	4 / 5	
Tube (cm)	50	45	45	42	42	36	36	50	45	
Number of airtight chambers	3	3	3	3	3	3	3	4	3	
Shaft	Long	Long	Short	Short	Short	Short	Short	Long	Long	
Max. power	25 HP	25 HP	25 HP	20 HP	15 HP	15 HP	10 HP	60 HP	50 HP	
Front locker	Standard	Standard	Standard	*	*	*	*	Standard	Standard	
Console & seat	Option 1	Option 1	Option 1	Option 1	-	-	-	Option	Option	
PVC Melher tech. valmex	Price	2 999 €	2 799 €	2 699 €	2 399 €	2 099 €	1 799 €	1 699 €	4 599 €	4 199 €
Hypalon Orca Pennel & Flipo	Price	4 999 €	4 599 €	4 299 €	3 299 €	2 999 €	2 499 €	2 299 €	6999 €	6 399 €

All prices are presented inclusive of VAT without transportation costs * Standard only on Hypalon Orca models

Make and model filed with WIPO and INPI (hull and deck plan, console and forceps, stainless steel seat). Prices and technical data subject to change without notice.

ULTRA LIGHT

RIB Aluminium



30 TENDER[®]
HIGH PERFORMANCE RESEARCH & DEVELOPMENT



ULTRA LIGHT RIB Aluminium

Semi rigid tender with ultra light aluminium hull!

The **Ultra Light RIB** range is available in seven models all made of **PVC Mehler Valmex® Technology** (German fabric) thermo-welded or glued hot also available in **Hypalon Orca Pennel & Flipo**.

Very light, with a very pronounced V shape that provides stability and exceptional passing through the waves and a navigation dry. Hull designed to withstand shock and abrasion associated with rocks, coral and sandy beach. Models above 330 cm are equipped with a front locker to store your nurse.

Incredibly rugged and lightweight!

STANDARD EQUIPMENT

- Fabric PVC Melher technology Valmex® glued or welded seams
- Inflation valves
- Aluminum hull, anti corrosion treated
- Marine paint on aluminum powder
- Anchor well on all hypalon models and on PVC models from 330 cm
- Front locker from 310 cm
- U-bolts of lifting and towing integrated to the hull
- Marine anti-skid surface, UV resistant
- Ultra wide band chafing
- Protection bow
- Aluminum bench
- Bag under bench
- Pump, oars, repair kit



Front locker
On all hypalon models and on all models from 380 to 310 cm

Dinghy wheels
99 € VAT inc.



Launching wheels
269 € VAT inc.



See details on console & accessories page 36 - 37

Available colors :

- PVC : White Red Blue
- Hypalon : Navi Blue Light Grey



ULTRA LIGHT RIB
290 > 250 CM

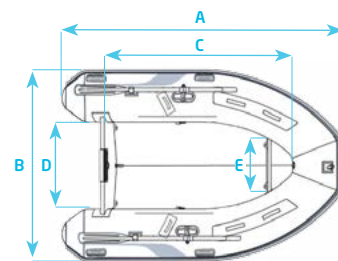

ULTRA LIGHT RIB
380 > 310 CM

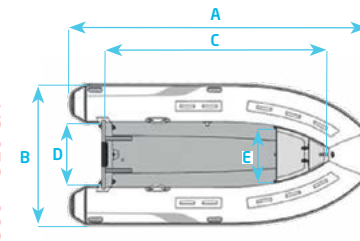

Specifications

Model	UL 380	UL 360	UL 330	UL 310	UL 290	UL 270	UL 250
A Overall length (cm)	380	360	330	310	290	270	250
B Overall beam (cm)	186	156	156	154	154	154	154
C Inside length (cm)	267	255	225	205	195	170	156
D Inside beam (cm)	86	68	68	66	66	66	66
E Bow locker width (cm)	67	60	60	-	70	70	70
F Stern height (cm)	108	90	90	-	54	54	54
G Bow height (cm)	52	52	51	51	45	45	45
Total weight (Kg)	69	57	44	34	31	28	24
Max. passengers	7	6	6	5	4	4	3
Max load (Kg)	700	650	500	500	450	450	350
Tube (cm)	45	45	42	42	42	42	42
Number of airtight chambers	3	3	3	3	3	3	3
Shaft	Short	Short	Short	Short	Short	Short	Short
Max. power	25 HP	25 HP	20 HP	15 HP	15 HP	10 HP	8 HP
Front locker	Standard	Standard	Standard	Standard	-	-	-
Bow roller	Standard	Standard	Standard	*	*	*	*
PVC Melher tech. valmex	Price	2 699 €	2 599 €	2 399 €	1 899 €	1 699 €	1 499 €
Hypalon Orca Pennel & Flipo	Price	4 499 €	4 299 €	3 299 €	2 799 €	2 399 €	1 999 €

All prices are presented inclusive of VAT without transportation costs * Standard only on Hypalon Orca models

Make and model filed with WIPO and INPI (hull and deck plan, console and forceps, stainless steel seat). Prices and technical data subject to change without notice.



ALUMINIUM SEMI-RIGID

FAST LINE

Foldable transom

The **Fast Line** has been specially created to facilitate the storage of your tender with its engine. A simple manipulation allows you to fold the transom in order that the engine do not exceed from the dimensions of the boat. Your tender can then be easily stored in a trunk or on the deck of your boat.

The hull is built in aluminium with a flat deck to ensure light weight and solidity. The V-shape of the hull also allows good speed and confort in all weather conditions.

STANDARD EQUIPMENT

- Foldable transom
- Fabric PVC Valmex®, Mehler Technologie glued or welded seams
- Inflation valves
- Aluminium hull, anti corrosion treated
- Marine paint on aluminium powder
- U-bolts of lifting and towing integrated to the hull
- Marine anti-skid surface, UV resistant
- Ultra wide band chafing
- Protection bow
- Aluminum bench
- Bag under bench
- Pump, oars, repair kit

OPTION

Dinghy wheels
99 € VAT inc.



Launching wheels
269 € VAT inc.



See details on console & accessories page 36 - 37

Available colors :

PVC : Blue Hypalon : Light Grey

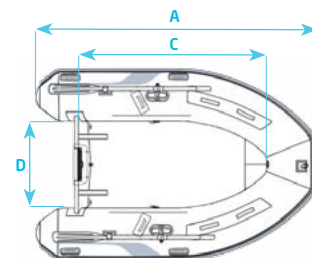

Specifications

Model	FL 240
A Overall length (cm)	240
B Overall beam (cm)	136
C Inside length (cm)	185
D Inside beam (cm)	65
F Stern height (cm)	65
G Bow height (cm)	75
Total weight (Kg)	34
Max. passengers	3
Max load (Kg)	320
Tube (cm)	36
Number of airtight chambers	3
Shaft	Short
Max. power	8 HP
PVC Melher tech. valmex	Price 1 999 €
Hypalon Orca Pennel & Flipo	Price 2 699 €

All prices are presented inclusive of VAT without transportation costs



Make and model filed with WIPO and INPI (hull and deck plan, console and forceps, stainless steel seat). Prices and technical data subject to change without notice.



LUX

Semi rigid tender with aluminium hull, front locker and protective cover in neoprene.

The LUX range is composed by 3 models all equipped with a front locker and a removable protective cover in neoprene for tube to ensure an optimal longevity.

Its hull has been designed in aluminium with a pronounced V-shape and a flat deck to offer the perfect balance between lightness, durability and seaworthiness.

ÉQUIPEMENT STANDARD

- Fabric PVC Valmex®, Mehler Technologie glued or welded seams
- White protective cover in neoprene
- Inflation valves
- Aluminium hull, anti corrosion treated
- Marine paint on aluminium powder
- Anchor well
- Front locker
- U-bolts of lifting and towing integrated to the hull
- Protective rubber
- Aluminium bench
- Pump, oars, repair kit

OPTION

Dinghy wheels
99 € VAT inc.



Launching wheels
269 € VAT inc.



See details on console & accessories page 36 - 37

Available colors : ■ Red

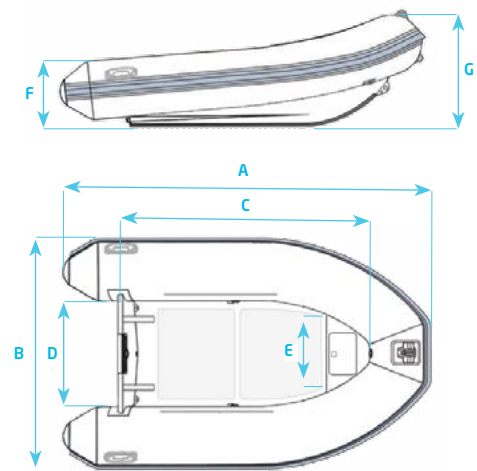

Specifications

Model	LUX 325	LUX 300	LUX 280
A Overall length (cm)	325	300	280
B Overall beam (cm)	156	155	140
C Inside length (cm)	225	195	193
D Inside beam (cm)	68	68	63
E Bow locker width (cm)	-	-	-
F Stern height (cm)	-	-	-
G Bow height (cm)	-	-	-
Total weight (Kg)	43	37	36
Max. passengers	4,5	4	3,5
Max load (Kg)	550	500	450
Tube (cm)	42	42	42
Number of airtight chambers	3	3	3
Shaft	Short	Short	Short
Max. power	15 HP	10 HP	10 HP
Bow locker	Standard	Standard	Standard
Bow roller	Standard	Standard	Standard
PVC Melher tech. valmex	Price	1 999 €	1 699 €
		1 699 €	1 499 €

All prices are presented inclusive of VAT without transportation costs

Make and model filed with WIPO and INPI (hull and deck plan, console and forceps, stainless steel seat). Prices and technical data subject to change without notice.

3D TENDER[®]
HIGH PERFORMANCE RESEARCH & DEVELOPMENT



FOLDABLE TENDERS



LT 240 Hypalon

Premium foldable tender in Hypalon.

The LT 240 is entirely build with *Hypalon Orca Pennel & Flipo*, A tissu worldwide recognize for its durability and its resistance to UV radiation. This tender is moreover build with a high pressure honeycomb floor to garanty lightness and ease of use.

STANDARD EQUIPMENT

- High pressure inflatable floor with honey-comb construction
- Anchor well
- Aluminium bench
- Oars
- Pump
- Repair kit

Model	LT 240
A Overall length (cm)	240
B Overall beam (cm)	150
C Inside length (cm)	179
D Inside beam (cm)	70
Total weight (Kg)	23
Max. passengers	3
Max load (Kg)	450
Tube (cm)	40
Number of airtight chambers	2+1
Shaft	Court
Max. power	6 HP
Dimensions in bag (cm)	90x45x30
Hypalon Orca Pennel & Flipo Price	1 599 €

All prices are presented inclusive of VAT without transportation costs

Make and model filed with WIPO and INPI (hull and deck plan, console and forceps, stainless steel seat). Prices and technical data subject to change without notice.



FROM ONLY
9,6 KG!



FROM ONLY
6,5 KG!



SUPERLIGHT TWIN AIR

3D TENDER developed the **SUPERLIGHT TWIN AIR** range to fit the expectations of pleasure boaters. Its high pressure floor with honeycomb construction as well as the materials used ensure the best balance between superlight weight, durability and ease of use. Storage on transportation are also facilitated, thanks to an adapted backpack.

STANDARD EQUIPMENT

- High pressure inflatable floor with honeycomb construction
- Aluminium bench
- Oars
- Pump
- Repair kit
- Backpack for storage and transport

Available colors:
White & Black

Model	TWA290	TWA270	TWA250	TWA230	TWA200	TWA180	TWA160
A Overall length (cm)	290	270	250	230	200	180	160
B Overall beam (cm)	136	135	135	134	131	129	129
C Inside length (cm)	234	215	195	177	145	126	106
D Inside beam (cm)	67	67	67	66	63	62	61
Total weight (Kg)	16,9	15,8	14,5	13,8	11,9	10,8	9,6
Max. passengers	4	3,5	3	2	2	1,5	1
Max load (Kg)	510	484	450	350	250	200	180
Tube (cm)	34-40	34-40	34-40	32-36	32-35	32-35	30
Number of airtight chambers	3+1	3+1	3+1	2+1	2+1	2+1	2+1
Shaft	Court	Court	Court	Court	Court	Court	Court
Max. power	10 HP	7.5 HP	7.5 HP	4 HP	3.5 HP	3.5 HP	2.5 HP
Dimensions in bag (cm)	98x48x28	98x48x28	98x48x28	90x45x28	90x45x28	90x45x28	90x45x26
PVC Melher tech. valmex	Price	949 €	899 €	799 €	699 €	649 €	599 €

All prices are presented inclusive of VAT without transportation costs

Make and model filed with WIPO and INPI (hull and deck plan, console and forceps, stainless steel seat). Prices and technical data subject to change without notice.

Specifications

SUPERLIGHT TWIN ROUND AIR

The use premium materials extremely light, and the absence of transom was the key elements to design the **SUPERLIGHT TWIN ROUND AIR**, which is the lightest tender available in the market. Once folded, it is also the smallest one to fit in small trunks.

STANDARD EQUIPMENT

- High pressure inflatable floor with honeycomb construction
- Motor support
- Aluminium bench
- Oars
- Pump
- Repair kit
- Backpack for storage and transport

Available colors:
White & Black

Model	TWRA250	TWRA235	TWRA200	TWRA180	TWRA160
A Overall length (cm)	250	235	200	180	160
B Overall beam (cm)	133	133	114,5	101,5	100,5
C Inside length (cm)	178	163	134	123	103
D Inside beam (cm)	61	61	48,5	44,5	43,5
Total weight (Kg)	12,2	11,8	9,2	7	6,5
Max. passengers	3	2	1,5	1	1
Max load (Kg)	400	350	250	200	180
Tube (cm)	36	36	33	28,5	28,5
Number of airtight chambers	2	2	2	2	2
Shaft	Short	Short	Short	Short	Short
Max. power	6 HP	5 HP	3.5 HP	2.5 HP	2 HP
Dimensions in bag (cm)	70x45x32	70x45x32	70x45x30	70x45x27	70x45x26
PVC Melher tech. valmex	Price	749 €	649 €	619 €	569 €

All prices are presented inclusive of VAT without transportation costs

Make and model filed with WIPO and INPI (hull and deck plan, console and forceps, stainless steel seat). Prices and technical data subject to change without notice.



FROM ONLY
19 KG!



FROM ONLY
19 KG!



SUPERLIGHT TWIN VIB AIR

With its V-shaped inflatable hull, the **Superlight Twin VIB Air** has been designed for boaters who look for speed and confort especially in difficult weather conditions. une mer formée. The tender is delivered with 2 disposable protective covers in neoprene, One black and one white, you can easily change the color of your boat.

STANDARD EQUIPMENT

- High pressure inflatable floor with honey-comb construction
- 2 protective cover in neoprene
- Aluminium bench
- Oars
- Pump
- Repair kit
- Backpack for storage and transport

Available colors : Black

Specifications

Model	TwVA330	TwVA300	TwVA280	TwVA250	TwVA210	
A Overall length (cm)	330	300	280	250	210	
B Overall beam (cm)	153	153	153	150	131	
C Inside length (cm)	-	-	-	-	-	
D Inside beam (cm)	-	-	-	-	-	
Total weight (Kg)	34	29	25	22	19	
Max. passengers	4,5	4	4	3	2	
Max load (Kg)	566	510	500	450	250	
Tube (cm)	42	42	42	42	36	
Number of airtight chambers	3+1	3+1	3+1	2+1	2+1	
Shaft	Short	Short	Short	Short	Short	
Max. power	15 HP	10 HP	10 HP	6 HP	3.5 HP	
Dimensions in bag (cm)	90x45x40	90x45x35	90x45x32	90x45x30	90x45x28	
PVC Melher tech. valmex	Price	1 399 €	1 099 €	999 €	899 €	799 €

All prices are presented inclusive of VAT without transportation costs

Make and model filed with WIPO and INPI (hull and deck plan, console and forceps, stainless steel seat). Prices and technical data subject to change without notice.

WORLD TRAVEL

3D TENDER developed his range to fit the expectations of pleasure boaters. His conical tubes bring a maximum of floatability. the storage and transportation are also facilitated, thanks to the adapted backpack.

STANDARD EQUIPMENT

- Slatted floor
- Aluminium bench
- Oars
- Pump
- Repair kit
- Backpack for storage and transport

Available colors : Black

Specifications

Model	WT235	WT200	
A Overall length (cm)	235	200	
B Overall beam (cm)	131	131	
C Inside length (cm)	183	147	
D Inside beam (cm)	60	60	
Total weight (Kg)	21	19	
Max. passengers	3	3	
Max load (Kg)	350	350	
Tube (cm)	37-32	37-32	
Number of airtight chambers	2	2	
Shaft	Short	Short	
Max. power	4 HP	4 HP	
Dimensions in bag (cm)	98x49x35	98x49x35	
PVC Melher tech. valmex	Price	399 €	379 €

All prices are presented inclusive of VAT without transportation costs

Make and model filed with WIPO and INPI (hull and deck plan, console and forceps, stainless steel seat). Prices and technical data subject to change without notice.

OPTION ANNEXES PLIABLES

Dinghy wheels
99 € VAT inc.





RESCUE BOAT

A boat with 100% self-draining system and extra reinforcements dedicated to professionals.

Boat specially design for an intensive usage, equipped with an ultra reinforced aluminium hull with **100% self-draining system**. The position of the liferopes and all the reinforcements have been specially studied to garanty the optimal longevity, the boat is therefor perfectly adapted to professionals' needs.

ÉQUIPEMENT STANDARD

- Reinforced aluminium hull
- Self-draining system
- Tissu PVC Melher technologie Valmex®
- Places adapted for fuel tank and battery
- U-bolts of lifting and towing integrated to the hull
- Anti-skid EVA pads on deck
- Ultra wide band chafing
- Protection bow
- Reinforced transom
- Pump, oars, repair kit

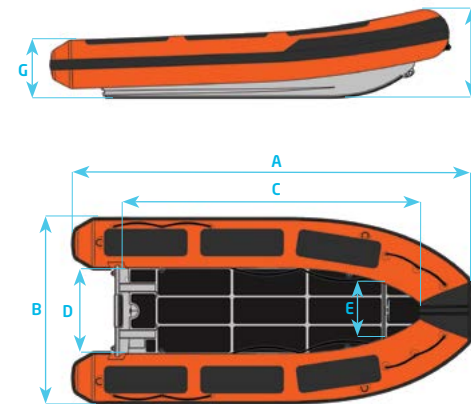

Model	430	370
A Overall length (cm)	430	370
B Overall beam (cm)	187	156
C Inside length (cm)	89	68
D Inside beam (cm)	-	-
E Bow locker width (cm)	67	58
F Stern height (cm)	103	89
G Bow height (cm)	126	75
Max. passenger	8	6
Total weight (Kg)	50	45
NNumber of airtight chambers	3	3
Shaft	Long	Long
Max. power (Ch/Kw)	60 HP	25 HP
Front locker	Standard	Standard
PVC Melher tech. valmex	Price	5 549 €
		4 199 €

Make and model filed with WIPO and INPI (hull and deck plan, console and forceps, stainless steel seat). Prices and technical data subject to change without notice.

3D TENDER ACCESSORIES



SEAT - REAR TRUNK L	REF: A01
Length (cm)	80
Beam (cm)	50
Seat height (cm)	
Total height (cm)	90
Price*	649 €

For PATROL 530, 550, XPRO 535, 490, 445, 420.



JOCKEY SEAT WINGS	REF: A05
Length (cm)	69
Beam (cm)	33
Seat height (cm)	57
Total height (cm)	96
Price*	829 €

For PATROL & XPRO RIB all sizes.



CONSOLE FRONT TRUNK L	REF: A09
Length (cm)	105
Beam (cm)	70
Seat height (cm)	38
Total height (cm)	140
Price*	1149 €

Standard on PATROL 600, 550
Option for XPRO 589.



CONSOLE JOCKEY CLUB	REF: A24
Length (cm)	125
Beam (cm)	45
Seat height (cm)	83
Total height (cm)	95
Price*	990 €



SEAT - REAR TRUNK XL	REF: A02
Length (cm)	92
Beam (cm)	52
Seat height (cm)	58
Total height (cm)	90
Price*	859 €

For PATROL 650, 600 - XPRO 589.



JOCKEY SEAT DOUBLE	REF: A06
Length (cm)	112
Beam (cm)	33
Seat height (cm)	68
Total height (cm)	99
Price*	1099 €

For PATROL & XPRO RIB all sizes.



CONSOLE FRONT TRUNK XL	REF: A10
Length (cm)	90
Beam (cm)	85
Seat height (cm)	45
Total height (cm)	140
Price*	1299 €

Standard on PATROL 650



LEANING POST	REF: A13
Length (cm)	42
Beam (cm)	50
Height (cm)	83
Price*	599 €

Standard on PATROL 530 & 560.



JOCKEY SEAT	REF: A03
Length (cm)	53
Beam (cm)	35
Seat height (cm)	57
Total height (cm)	96
Price*	599 €

For PATROL & XPRO RIB all sizes.



BOLSTER SEAT L	REF: A07
Length (cm)	80
Beam (cm)	40
Seat height (cm)	82
Total height (cm)	98
Price*	699 €

Standard on PATROL 600, 550, XPRO 589.



CONSOLE	REF: A11
Length (cm)	83
Beam (cm)	62
Seat height (cm)	46
Total height (cm)	149
Price*	899 €

Standard on PATROL 530 & 560



TIP TOP	REF: A14
Length (cm)	160
Beam (cm)	130
Height (cm)	190
Console max width (cm)	114
Price*	1399 €

For PATROL & XPRO



JOCKEY SEAT PILOT	REF: A04
Length (cm)	69
Beam (cm)	33
Seat height (cm)	68
Total height (cm)	96
Price*	599 €

For PATROL & XPRO RIB all sizes.



BOLSTER SEAT XL	REF: A08
Length (cm)	95
Beam (cm)	35
Seat height (cm)	85
Total height (cm)	98
Price*	799 €

Standard on PATROL 650



JOCKEY CONSOLE	REF: A12
Length (cm)	135
Beam (cm)	50
Seat height (cm)	55
Total height (cm)	90
Price*	999 €

For XPRO RIB 360, 390, 415, 420, 445, 490.



ICE BOX	REF: A21
Length (cm)	40
Beam (cm)	72
Height (cm)	42,5
Price*	139 €



ROLL BAR SIMPLE
REF: A15
for PATROL all sizes
399 €*



ROLL BAR PATROL
REF: A16
for PATROL all sizes
699 €*



ROLL BAR XPRO
REF: A17
for XPRO 589, 535, 490, 445
699 €*



BOX TIPTOP
REF: A25
for tip top
299 €*



FISHING ROD HOLDER
REF: A18
for roll bar & tip top
69 €*



DOUBLE FISHING ROD HOLDER
REF: A19
for roll bar & tip top
99 €*



FISHING ROD HOLDER - 5 RODS
REF: A20
for roll bar & tip top
249 €*



DINGHY WHEELS
REF: A22
99 €*

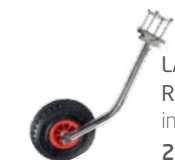

LAUNCHING WHEELS
REF: A23
in aluminium
269 €*

* VAT included - without transportation costs



PACK BOAT + MOTOR

Prices for information purpose only, may change without notice. For any other boat with a motor over 20 HP, please contact your authorized dealer.

PRICE VAT INCLUDED without transportation costs



FOLDABLE ALUMINIUM

MODEL	BOAT ONLY	BOAT + 2,5 HP	BOAT + 6 HP	BOAT + 15 HP	BOAT + 20 HP
XPRO Heavy Duty 320	1 599 €	2 048 €	2 648 €	4 710 €	-
XPRO Heavy Duty 360	1 799 €	2 207 €	2 807 €	4 869 €	5 282 €
XPRO Heavy Duty 380	1 899 €	-	2 867 €	4 929 €	5 342 €
XPRO Heavy Duty 420	2 099 €	-	3 131 €	5 194 €	5 606 €
XPRO Heavy Duty 460	2 399 €	-	3 266 €	5 329 €	5 741 €
XPRO Heavy Duty 500	2 829 €	-	3 435 €	5 498 €	5 910 €
XPRO Heavy Duty 550	3 099 €	-	3 551 €	5 614 €	6 026 €
PATROL 380	1 999 €	-	2 923 €	4 986 €	5 398 €
PATROL 425	2 299 €	-	3 043 €	5 106 €	5 518 €
PATROL 475	2 499 €	-	3 236 €	5 299 €	5 711 €

FOLDABLE TENDERS

MODEL	TENDER ONLY	TENDER+ 2,5 HP	TENDER + 6 HP	TENDER + 15 HP	TENDER + 20 HP
TWIN AIR 160	549 €	1 268 €	-	-	-
TWIN AIR 180	599 €	1 316 €	-	-	-
TWIN AIR 200	649 €	1 350 €	-	-	-
TWIN AIR 230	699 €	1 376 €	-	-	-
TWIN AIR 250	799 €	1 455 €	2 055 €	-	-
TWIN AIR 270	899 €	1 530 €	2 130 €	-	-
TWIN AIR 290	949 €	1 586 €	2 186 €	-	-
TWIN ROUND AIR 160	509 €	1 254 €	-	-	-
TWIN ROUND AIR 180	569 €	1 273 €	-	-	-
TWIN ROUND AIR 200	619 €	1 324 €	-	-	-
TWIN ROUND AIR 235	649 €	1 363 €	-	-	-
TWIN ROUND AIR 250	749 €	1 436 €	2 036 €	-	-
TWIN VIB AIR 210	799 €	1 562 €	-	-	-
TWIN VIB AIR 250	899 €	1 721 €	2 321 €	-	-
TWIN VIB AIR 280	999 €	1 779 €	2 379 €	-	-
TWIN VIB AIR 300	1 099 €	1 913 €	2 513 €	-	-
TWIN VIB AIR 330	1 399 €	2 018 €	2 618 €	4 680 €	-
WORLD TRAVEL 200	379 €	1 215 €	-	-	-
WORLD TRAVEL 235	399 €	1 236 €	-	-	-
LT Hypalon 240	1 599 €	2 231 €	2 831 €	-	-

ALUMINIUM SEMI-RIGID

MODEL	TENDER ONLY	TENDER + 2,5 HP	TENDER + 6 HP	TENDER + 15 HP	TENDER + 20 HP
XPRO RIB Alu 260 - PVC	1 699 €	2 205 €	2 805 €	-	-
XPRO RIB Alu 260 - Hypalon	2 299 €	2 959 €	3 559 €	-	-
XPRO RIB Alu 280 - PVC	1 799 €	2 299 €	2 899 €	4 961 €	-
XPRO RIB Alu 280 - Hypalon	2 499 €	3 101 €	3 701 €	5 764 €	-
XPRO RIB Alu 300 - PVC	2 099 €	2 528 €	3 128 €	5 190 €	-
XPRO RIB Alu 300 - Hypalon	2 999 €	3 514 €	4 114 €	6 176 €	-
XPRO RIB Alu 325 - PVC	2 399 €	2 704 €	3 304 €	5 366 €	5 779 €
XPRO RIB Alu 325 - Hypalon	3 299 €	3 643 €	4 243 €	6 306 €	6 718 €
XPRO RIB Alu 360 - PVC	2 699 €	3 133 €	3 733 €	5 796 €	6 208 €
XPRO RIB Alu 360 - Hypalon	4 299 €	4 521 €	5 121 €	7 183 €	7 596 €
XPRO RIB Alu 390 - PVC	2 799 €	-	3 823 €	5 886 €	6 298 €
XPRO RIB Alu 390 - Hypalon	4 599 €	-	5 383 €	7 446 €	7 858 €
XPRO RIB Alu 415 - PVC	2 999 €	-	4 003 €	6 066 €	6 478 €
XPRO RIB Alu 415 - Hypalon	4 999 €	-	6 026 €	8 089 €	8 501 €
XPRO RIB Alu renforcé 390 - PVC	4 199 €	-	5 078 €	7 140 €	7 553 €
XPRO RIB Alu renforcé 390 - Hypalon	6 399 €	-	7 052 €	9 114 €	9 527 €
XPRO RIB Alu renforcé 420 - PVC	4 599 €	-	5 483 €	7 545 €	7 958 €
XPRO RIB Alu renforcé 420 - Hypalon	6 999 €	-	7 568 €	9 630 €	10 043 €

MODEL	TENDER ONLY	TENDER + 2,5 HP	TENDER + 6 HP	TENDER + 15 HP	TENDER + 20 HP
ULTRA LIGHT 250 - PVC	1 499 €	2 089 €	2 689 €	-	-
ULTRA LIGHT 250 - Hypalon	1 999 €	2 616 €	3 216 €	-	-
ULTRA LIGHT 270 - PVC	1 599 €	2 121 €	2 721 €	-	-
ULTRA LIGHT 270 - Hypalon	2 099 €	2 734 €	3 334 €	-	-
ULTRA LIGHT 290 - PVC	1 699 €	2 151 €	2 751 €	4 813 €	-
ULTRA LIGHT 290 - Hypalon	2 399 €	2 981 €	3 581 €	5 644 €	-
ULTRA LIGHT 310 - PVC	1 899 €	2 449 €	3 049 €	5 111 €	-
ULTRA LIGHT 310 - Hypalon	2 799 €	3 375 €	3 975 €	6 038 €	-
ULTRA LIGHT 330 - PVC	2 399 €	2 715 €	3 315 €	5 378 €	5 790 €
ULTRA LIGHT 330 - Hypalon	3 299 €	3 619 €	4 219 €	6 281 €	6 694 €
ULTRA LIGHT 360 - PVC	2 599 €	2 886 €	3 486 €	5 548 €	5 961 €
ULTRA LIGHT 360 - Hypalon	4 299 €	4 496 €	5 096 €	7 159 €	7 571 €
ULTRA LIGHT 380 - PVC	2 699 €	-	3 574 €	5 636 €	6 049 €
ULTRA LIGHT 380 - Hypalon	4 499 €	-	5 359 €	7 421 €	7 834 €
FAST LINE 240 - PVC	1 999 €	2 363 €	2 963 €	-	-
FAST LINE 240 - Hypalon	2 699 €	3 075 €	3 675 €	-	-
LUX 280	1 499 €	2 342 €	2 942 €	-	-
LUX 300	1 699 €	2 561 €	3 161 €	-	-
LUX 325	1 999 €	2 730 €	3 330 €	5 393 €	-



3D TENDER®
HIGH PERFORMANCE RESEARCH & DEVELOPMENT

3D MARINE - 520 route de Penetty - 29850 GOUESNOU - France

More informations on :

WWW.3DTENDER.COM

Or contact our advisor: Mr Olivier DALIDEC
(+33) 06 81 31 19 36 - international@3dtender.com

