

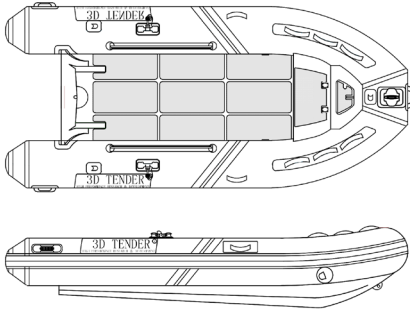

OWNER MANUAL



STEALTH RIB Aluminium
550, 500, 460, 420, 390, 360

Summary :

- Introduction 2
- Warranty Informations..... 2
- Safety Alerts 4
- Safe boating recommendations..... 5
- Craft data 7
- Transporting..... 9
- Operation 9
- Outboard motor 14
- Maintenance..... 15
- Storage 17
- Service assistance 17

INTRODUCTION

Congratulations on your purchase of a 3D Tender Boat. We are convinced it will bring years of boating plaisir. However, for your security and to ensure that you gain maximum satisfaction, please read this user manual carefully. It contains all the safety and operation instructions that you need to get the most out of your new 3D Tender boat.

The operator, passengers and craft are governed by local, national and when applicable, international rules and regulations. If you are not familiar with this rules and regulations, please contact your local authorities. Many accident involve inexperienced operators. Make sure that you are qualified and that you only lend your boat to other qualified operators.

Caution

- Please keep this manual in a safe place and easily accessible.
- This manual is part of the boat's equipment, hand it over to the new owner if you sell your boat.

WARRANTY INFORMATIONS

WHAT IS COVERED :

3D Tender boats are warranted to be free of defects in material and workmanship during the period described here after.

DURATION OF COVERAGE :

The entire boat is covered for a period of 2 year from the date the product is sold.

If you use the boat for commercial purpose or renting, the entire boat is covered for a period of 1 year from the date the product is sold.

WHAT 3D TENDER WILL DO :

3D TENDER sole exclusive obligation under the warranty is limited to, at our option, repairing a defective part, replacing such part or refunding the purchase price of product. The repair, replacement of parts, or the performance of service under this warranty does not extend the life of this warranty beyond its original expiration date.

In the hypothetical case where the product have to be refunded. An annual depreciation of 20% will be applied on the price indicated on the original invoice and from the date the product is sold.

HOW TO OBTAIN THE WARRANTY :

The customer must provide 3D Tender boats with a reasonable opportunity to repair, and reasonable access to the product for warranty service. Warranty claims shall be made by delivering the product for inspection to a 3D Tender dealer authorized to service the product.

If the service provided is not covered by this warranty, the purchaser shall pay for all related labor and material, and any other expenses associated with that service.

The purchaser shall not, unless requested by 3D Tender, ship the product or parts of the product directly to 3D Tender.

3D TENDER or his authorized dealer will decide if they have to repair the defective part under warranty or not.

Proof of ownership must be presented to the dealer at the time the warranty service is requested in order to obtain coverage.

The warranty require this inspection of the boat 12 months after the date of purchase by an authorized agent. Every defects on the boat will be repaired under warranty. The servicing and transportation will be supported by the user, as well as all the damages caused by the use of the product.

WHAT IS NOT COVERED :

The limited warranty does not include the following elements :

1. An inadapated storage or transport, or any other use contrary to the instructions of this manual.
2. The deterioration due to natural elements, the perforation, the discoloration, the oxidation, the abrasion, the moulds
3. Dammages due to loss or theft.
4. Wearing parts, including keel guard, ropes and rubbing strake.
5. Reparation without autorisations, as well as modifications or alterations of all coponents or part of the boat.
6. This warranty will not be possible if the boat has been used with an incorrect tube pressure or with an outboard motor that exceed the maximum power indicated on the manufacturer's plate fixed on the transom of the boat.
7. Slighter dammages on FRP hulls, such as :
 - Slight damage on the gelcoat, cracks, protuberances and runs.
 - natural loss of color due to weather conditions, or due to a contact with aggressive and contaminant environnements.

8. Using the boat for races or any activity of competition cancel the limited warranty.
9. Works of assembly and disassembly the equipments of the boat, as well as transportations to, and from the service station are at the expense of the owner.
10. Expences linked to towing, rental, insurance, loan, loss of use, loss of income, or any other direct or indirect dammages are not covered by this warranty.
11. On all boat equipped with an aluminium hull, an anode is compulsory in order to avoid all problemes linked to electrolysis. Any use of a alumium boat without an anode cancel the limited warranty of the boat.
12. On the models XPRO 589, 535, 490 et 445, the hull has not been design to create cable passage. All cable passage must be on the deck in a sleeve. Any drilling of the composite wall cancel the limited warranty of the boat.

TRANSFERT OF WARRANTY :

The limited warranty is transferable to a subsequent purchaser, but only for the remainder of the unused portion of the limited warranty. This does not apply if the vessel is used for rental or commercial use. To transfer warranty, please send an email with the below information to : international@3dtender.com

- Copy of the sale agreement
- HIN number of the craft
- Name, adress, email address of the new owner

SAFETY ALERTS :

This manual uses the following safety alerts to draw your attention to special safety instructions that should be followed.

Degree of hazard and correspondingsafety labels :

Danger

Denotes that an extreme intrinsic hazard exists which would result in high probability of death or irreparable injury if proper precautions are not taken.

Warning

Denotes that hazard exists which can result in injury or death if proper precautions are not taken.

Caution

Denotes a reminder of safety practices or directs attention to unsafe practices which could result in personal injury or damage to the craft or components or to the environment.

SAFE BOATING RECOMMENDATIONS :

1 - Always wear a life jacket

Local authorities require that you carry an approved flotation device, or life jacket, for each person aboard your vessel. We recommend wearing a life jacket at all times while boating because you never know when an accident may occur. Statistics show nine of ten drowning victims may have survived a capsizing or fall overboard if they had been wearing a life jacket, so choose a life jacket you will wear.

2 - Use the kill switch lanyard

The operator of the boat must at all time wear a kill switch lanyard while driving . In the event of accidental ejection or loss of balance, the boat will shut off automatically. Possibility saving the driver's life or that of someone else's. Tiller handle outboards and some remote control units are equipped with a lanyard stop switch. A lanyard stop switch can be installed as an accessory on the dashboard or adjacent to the operator's position.

3 - Protect people in the water

Always slow down and exercise extreme caution anytime you are boating in an area where there are people in the water. Please remember that even if the outboard gear shift is in neutral position the propeller may continue to rotate enough to cause serious injury.

4 - Know your boat

Knowing your boat is the foundation of good seamanship, which is simply managing a boat and encompasses : navigation, safety, boat handling, line handling, anchoring, troubleshooting of engine problems, and appropriate emergency response.

5 - Take a boat safety course

85%of boating fatalities involve operators who did not have formal boating education. A boating course will teach you the basics of seamanship mentioned above . The knowledge you will gain by taking a boating safety course will never be wasted.

6 - Boat sober

Alcoholic drinks are even more dangerous on th water than on land because the marine environment accelerates impairment. In boating deaths attributed to alcohol use, over half capsized or fell overboard. Besides the safety risks, boating while intoxicated, or BUI, is illegal and heavy penalties are enforced by both state and federal agencies.

7 - Know the navigation rules

Aids to navigation such as buoys and day boards help us navigate in potentially dangerous waters. Learn to read nautical charts, and keep them on your vessel to become familiar with the area in which you boat. Taking a boating safety course is the next step, where you will learn to navigate using charts, GPS, RADAR, and a compass.

Danger

When operating, passengers must avoid standing up or hanging appendages outside of the boat. Leaking fuel is a fire hazard, inspect fuel system regularly. Shut off the engine before boarding from the water.

Warning

Should the operator or passenger fall out the boat, the possibility of serious injury or death from being run over by the boat can be greatly reduced by stopping the engine immediately. Always properly connect both ends of the stop switch lanyard to the stop switch and the operator.

Caution

Passengers must use suitable PFDs. Special PFDs are designed for children or watersports activities.

FIRE SAFETY :

Your boat has been conceived to be used with an outboard motor. In order to protect you from all the risks of fire, make sure that your boat is equipped with the appropriate equipment for firefighting.

All boats equipped with an outboard motor with a power superior to 25Kw must be equipped with at least one portable extinguisher, the model and size must be suitable to inundate the fuel compartment via an extinguishment orifice located on the wall of this compartment. This extinguisher must be located at less than one meter from the cockpit area and easily accessible in case of emergency.

If you want to install a fuel tank in your boat, make sure before use that the installation and fire protection systems conform with the norm ISO 9094-1 relative to fire protection on boat under 15 meters long.

CRAFT DATA :

Spécifications :

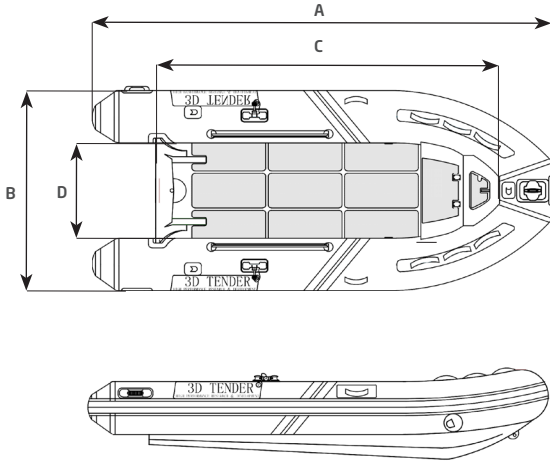

Model	ST 550	ST 500	ST 460	ST 420	ST 390	ST 360
A Overall length (cm)	550	500	460	420	390	360
B Overall beam (cm)	220	220	201	201	190	190
C Inside length (cm)	426	379	362,5	318	299	259
D Inside beam (cm)	118	118	105	105	94	94
Hull angle (degree)	24	24	20	20	22	22
Aluminium Thickness (cm)	0,4	0,4	0,4	0,4	0,4	0,3
Total weight* (Kg)	240	220	171	137	91	-
Category	C	C	C	C	C	C
Maximum number of	12	11	9	8	7	6
Maximum load (Kg)	1350	1000	900	800	700	600
Tube (cm)	51	51	48	48	48	48
Shaft	Long	Long	Long	Long	Long	Long
Maximum power	70 HP	70 HP	60 HP	50 HP	50 HP	25 HP
Front trunk	Double	Double	Double	Double	Double	Double
Package dimensions	500x145x112	425x145x112	405x135x106	380x135x106	360x115x80	324x115x80

Manufacturer's plate :

- a - Name of manufacturer
- b - Model
- c - Category
- d - Maximum number of persons
- e - Maximum load capacity
- f - Maximum motor power
- g - Recommended working pressure
- h - HIN : Hull Identification Number

Manufacturer 3D Marine LTD
WWW. 3dtender.com

Model

Category

Nos. of person

Max. load kg

Max. motor capacity kw

Working pressure-boat 0.25 bar

Working pressure-air floor 0.5 bar

Serial No.

The manufacturer's plate is located on the inside of the boat transom.

Boat design category according to ISO 10240 :

Category A : Craft design to operate in winds that may exceed wind force 8 (Beaufort scale) and in significant wave heights of 4 meters and above, and is largely self-sufficient. Abnormal conditions such as hurricanes are excluded. Such conditions may be encountered on extended voyages, for example across oceans, or inshore when unsheltered from the wind and waves for several hundred nautical miles.

Category B : Craft designed to operate in winds up to Beaufort force 8 and the associated wave heights (up to 4 meters included). Such conditions may be encountered on offshore voyages of sufficient length, or on coastal waters when unsheltered from the wind and waves for several dozens nautical miles. These conditions may also be experienced on inland seas of sufficient size for the wave height to be generated.

Category C : Craft designed to operate in winds up to Beaufort force 6 and the associated wave heights (significant wave height up to 2 meters). Such conditions may be encountered in exposed internal waters, in estuary or in coastal waters with moderate weather conditions.

Category D : Craft designed to operate in winds up to Beaufort force 4 and the associated wave heights (significant wave height up to 0,5 meters). Such conditions may be encountered in protected internal waters and in coastal waters with good weather conditions.

TRANSPORTING :

For optimum handling, the trailer must be properly loaded and balanced.

Keep the center of gravity low for best handling.

Approximately 60 percent of the boat's weight should be positioned on the front half of the trailer and 40 percent in the rear.

The boat should also be balanced from side to side. If the vessel has side mounted fuel or water tanks and only one side is filled, then this will lend the rig to maneuver poorly. Proper balancing will also prolong the life of your trailer tires.

The boat should also be firmly secured with at least two ratchet type straps, one attached from the trailer to the stem eyes and one strap from the trailer to the bow eye to keep the boat from shifting forward. The bow eye should also be attached to the trailer's winch which is mounted forward of the bow. Make sure you have sufficient clearance to avoid to damage outboard or boat during transportation. Some foldable tenders can be accomodate / transported on a roof rack. We recommend the boat to be protected from the roof rack that could damage the tube material. Boat should be stowed upside down. Oars, bench seat and equipments should be removed from the boat. Boat must be secured using reliable nylon tie dow, straps with cam buckles.

OPERATION :

Pre-operation check list :

- Check the pressure level in each chamber using a pressure gauge. Recommended working pressure is displayed on manufacturer's plate.
- Make sure the outboard motor is securely fastened to the transom.
- Make sure the drain plug is fully functional.
- Check fuel tank level and make sure it suits you plan.
- Start the outboard motor and make sure it stops when the lanyard is disconnected from the switch.
- Make sure you and every passenger are wearing a suitable personal flotation device.
- Make sure there is an extra buoyant device that can be thrown to rescue person in the water.
- Check that the boat is equipped with 2 paddles or oars.
- Make sure the load in the boat is distributed evenly.
- Check that every passenger is securely seated and holds a safe line, grab handle or rope.
- Make sure that there is a 4 meters towing rope in the boat.
- If boating with pasengers, instruct at least one passenger in the basics of boat handling, starting and operation of the outboard motor.
- Make sure that all safety gear is on board (whistle, floating ropes, waterproof flashlight, first aid kit, fresh water, tool kit ...)

Inflation :

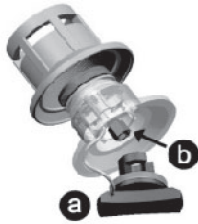

a - Valve cap
b - Plunger

To inflate the chamber, first unscrew the valve cap by turning a quarter of a turn counterclockwise. Check that the plunger in the center of the valve is closed (upper position) . If open (spring compressed, down position) push the plunger down and rotate to the closed position.

Connect the air pump to the valve, rotate the connector into the valve to lock it and start inflating.

Inflate each chamber in turn, do not inflate a chamber completely then move on to the next one. Start with the rear chambers. repeat procedure until all chambers are evenly inflated to the recommended working pressure. Use air gauge to measure the tube pressure. If you do not have any gauge, firmly press the tube with one finger, if it goes down by about 10mm, the tube pressure is correct.

Inflatable boats can be damaged by extreme internal air pressure. Such pressure can be caused by temperature differences. A boat properly inflated in the morning may become dangerously over pressurized as the day warms up. The internal pressure can multiply many times as the surface temperature increases and under such conditions, seams can separate and bonded materials can delaminate. Avoid subjecting your inflatable to such conditions by relieving pressure in all chambers of your boat as the day heats up or before leaving the boat exposed to hot midday sun. It is highly recommended that the boat be stored in the shade or under cover when it is not being used.

Do not use a compressed air source to inflate the tube or you may compromise the integrity of the seams or internal baffle rupture. Seams or baffle rupture due to non respect of inflation procedure is not covered under the warranty.

Using the boat with under inflated tubes may cause serious damage, including transom cracking.

Caution

Do not use compressed air source to fill the air chambers. Over inflation may result in seams or diaphragms rupture.

Use of drain plug

Your boat is equipped with self bailing system, with one or two fabric venturi drains. During normal navigation, the venturi drains would normally be left "down" to ensure any water to be drained from the deck.

If the boat is to be left in the water unattended, the venturi drains should be left in the "up" position. However if there is to be heavy rain the venturi drains may then be left down to ensure water drains from the deck. Whilst they are down there is a chance that a small amount of water enter into the boat through the drains and therefor should be monitored. Normal storage of a vessel such as this would be on a trailer or cradle and the venturi drains should be left down to ensure all water, fumes etc can drain from the deck.

To drain the bilge area, please unscrew the plug which is installed on the transom. Make sure this plug is correctly screwed before using the boats.

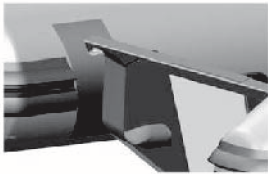

Up position



Down position

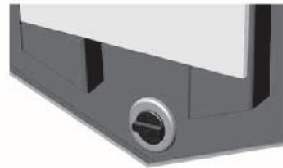

Caution

Keep the drains open when the boat is kept outside of the water. The rain water could fill the boat and create stress and damage.

Danger

Do not open the drain plug when the boat is afloat but not in motion.

Load distribution

Please refer to the maximum number of passengers and load capacity of the boat in this manual or on the manufacturer's plate. Do not exceed the maximum number.

Position the passengers and distribute the load evenly in the boat to help counterbalance the weight of the outboard.

In rough waters, load can be moved forward to ease the motion of the craft.

Performance

To achieve best performance, the boat must plane. If the boat does not plane, you may check the following:

- Make sure the bilge / deck is dry, drain the water otherwise.
- Make sure the tube is correctly inflated.
- Make sure you have the correct weight distribution. Sea conditions may require passengers to move forward to the boat to get the boat on plane before they return to their initial positions.

The outboard engine plays a big role in the performance of the boat. Please make sure you use a suitable outboard engine for the boat.

Outboard trim angle can be adjusted to improve planing and general performance. Adjust the position of the trim rod of your motor to define the trim angle of the outboard motor in relation to the transom. Make test runs with the trim set to different angles to find the position that works best for your boat and operating conditions.

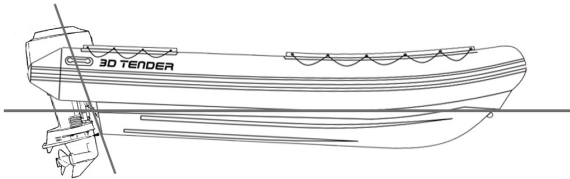

Bow down, too much trim-in

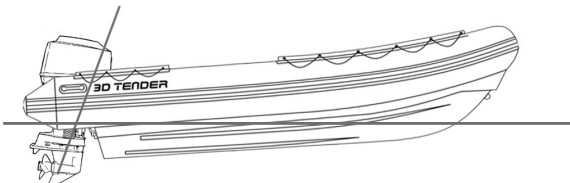

Bow up, too much trim-out

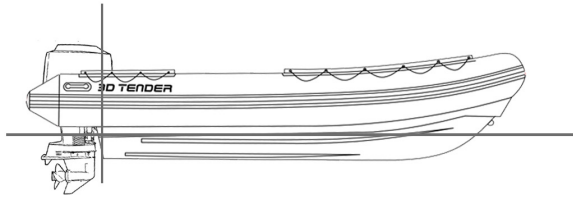

Right position

Towing

Your boat can be towed using the towing eye located at the bow. The boat must be empty when towed. Remove outboard motor, fuel tank and equipment. No passenger should be aboard. The boat should be towed at low speed. Make sure to use a tow line that is rated at least 5 times the weight of the boat being towed. The boat should only be towed using the towing eye. Molded handles, lifelines and cleats are not designed to be used for towing.

- 1 - It is recommended that the boat be towed with a bridle arrangement using a D-rings on the either side of the bow.
- 2 - An extra safety line should be attached to the welded-on aluminium eye under the bow of the hull.
- 3 - Please note that towed dinghies need to be constantly monitored and especially at night.
- 4 - When a dinghy is towed, the conditions may vary quite dramatically so the responsibility for its security rests entirely with the skipper.

Warning

No passenger should be onboard. Boat shall be towed at low speed. Make sure to use a tow line that is rated at least 5 times the weight of the boat being towed

Lifting

To lift your boat or stow your boat under gravity davits, use the lifting points provided for this purpose or have them installed by a professional.

Warning

No passenger must be onboard during lifting.

Caution

The boat must be unloads of all equipment during lifting. The drain plugs must be open and the boat must be tilting backward in order to ensure the potential water drain.

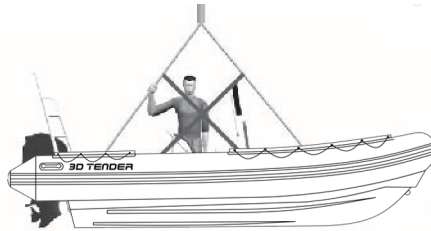

Beaching

We recommended the boat not to be powered onto the beach, dragged across rocks, sand, gravel or pavement as damage to the fabric and / or hull may result.

OUTBOARD MOTOR :

Install the outboard motor on the transom so that it is positioned as close to the center as possible. Tighten the transom clamp screws evenly and securely. Occasionally check the clamp screws for tightness during operation of the outboard motor because they could become loose due to engine vibration. It is wise to tie the engine to the transom as well as clamping eyes are provided. Always use the kill switch lanyard properly.

The portable tank should be removed from the boat when fuelling. The tank should be filled in a ventilated area.

Do not smoke aboard.

Warning

Overpowering a boat can result in serious injury, death or boat damage. Do not use outboard that exceeds the maximum horsepower given on the motor plate.

MAINTENANCE

General care :

Your inflatable has been especially designed to avoid maintenance problems as far as possible. However, periodic cleaning will help to keep your boat's good condition especially before winter storage. Clean your boat and wash it thoroughly with soapy water. Rinse carefully and check that no dirt or foreign bodies such as shell, sand or fishing hooks are left inside that might deteriorate the fabric. For tar stains use a gentle, non-abrasive cleanser such as dishwashing soap, or use a recommended inflatable boat cleaner available from most boat chandlery outlets.

CAUTION

- Do not use abrasive or aggressive chemical compounds
- Warm soapy water is best in most situations
- Do not use any solvents, petrol, etc (PVC models)
- Use solvents sparingly only on Hypalon models
- Test any cleaner on a piece of patch materials if in doubt

Tube repair

Repair kit contains :

- Fabric patches
- Ready to use tube of special glue

Conditions necessary for a successful repair :

- Humidity max 60%
- Temperature range between 18 and 25 degrees Celsius
- Repairs should not be carried out in direct sunlight, wind or rain
- Repairs should, however, be undertaken in a well ventilated area

Repair PVC boat :

3D Tender boats that have tubes constructed with PVC fabrics require PU based adhesive and RC hardener. Acetone solvent is recommended to prepare the surface before gluing. Use only recommended solvent and adhesive.

Identify the area to be patched. This can be done by running water over the suspect area or spraying or brushing with soapy water.

If the hole is only small, cut out a round patch of no less than 60 mm diameter. Larger holes or cuts will require proportionately larger patches but always ensure you have at least 30 mm of patch around the perimeter of the cut or hole and the corner are well radiused.

Next hold the patch on the tube and mark out around it with a pencil.

Clean both surfaces with solvent and spread a thin layer of adhesive over them ensuring there are no lumps.

When first coat is dry to the touch (about 10 to 15 minutes) apply a second thin coat. After waiting 5 or 6 minutes, touch the adhesive with the back of your hand. If it no longer appears wet, heat both areas with a hot air gun to re-activate the glue and join the patch to the tube and then clamp or roll the surfaces together. For the best adhesion, roll over the patch with a roller or over the bottom edge of a bottle.

Do not inflate the boat fully for 24 hours.

Repair Hypalon boats

3D Tender boats that have tubes constructed with Orca Hypalon coated fabrics cannot be bonded with plastic adhesive or by welding. They require neoprene based glue and RFE hardener. MEK solvent is recommended to prepare the surface before gluing. Use only recommended solvent and adhesive.

Identify the area to be patched. This can be done by running water over the suspect area or spraying or brushing with soapy water.

If the hole is only small, cut out a round patch of no less than 60 mm diameter. Larger holes or cuts will require proportionately larger patches but always ensure you have at least 30 mm of patch around the perimeter of the cut or hole and the corner are well radiused.

Next hold the patch on the tube and mark out around it with a pencil.

Use a grinder, coarse sand paper or scratch stone, rough up both the back of the patch and the area marked on the tube.

Clean both surfaces with solvent and spread a thin layer of adhesive over them ensuring there are no lumps.

When first coat is dry to the touch (about 10 to 15 minutes) apply a second thin coat. After waiting 5 or 6 minutes, touch the adhesive with the back of your hand. If it no longer appears wet, heat both areas with a hot air gun to re-activate the glue and join the patch to the tube and then clamp or roll the surfaces together. For the best adhesion, roll over the patch with a roller or over the bottom edge of a bottle.

Do not inflate the boat fully for 24 hours.

Danger

Glue and solvents used for repair are highly flammable. Perform repairs in a well ventilated area. Avoid breathing the vapors, wear protective gear (goggles, filter respirators, latex gloves).

Upholstery

3D TENDER is using marine grade upholstery fabric to offer best resistance to UV and ageing. Periodic washing with mild detergent and warm water is the best way to keep your upholstery look good. Special vinyl cleaner can also be used to remove difficult stains. No fabrics can last forever when constantly exposed to the elements. We therefore recommend you to cover your boat when not in use.

STORAGE

When not in use, boat should be removed from water.

Before storage the boat should also be cleaned and rinsed with fresh water.

Do not cover boat before it is completely dry or mildew could grow under the cover and damage the tube material. The covers should be ventilated and the drain plug left out.

SUPPORT SERVICE

For assistance, please contact your 3D Tender dealer or visit our website : www.3dtender.com